

A SOURCEBOOK
FOR INDUSTRY



**Improving Motor and
Drive System Performance**

DISCLAIMER

This publication was prepared by the Washington State University Energy Program and the National Renewable Energy Laboratory for the U.S. Department of Energy's Office of Energy Efficiency and Renewable Energy. Neither the United States, DOE, the Copper Development Association, the Washington State University Energy Program, National Electrical Manufacturers Association, nor any of their contractors, subcontractors, or employees makes any warranty, express or implied, or assumes any legal responsibility for the accuracy, completeness, or usefulness of any information, apparatus, product, or process described in this guidebook. In addition, no product endorsement is implied by the use of examples, figures, or courtesy photos.

ACKNOWLEDGMENTS

Improving Motor and Drive System Performance: A Sourcebook for Industry was developed for the U.S. Department of Energy's (DOE's) Advanced Manufacturing Office (AMO) with support from the Copper Development Association (CDA). AMO undertook this project as a series of sourcebook publications. Other topics in this series include: *compressed air systems, pumping systems, fan systems, process heating, and steam systems*. For more information about program resources, see AMO in the "Where to Find Help" section of this publication. Thanks are extended to AMO and to Rolf Butters, Scott Hutchins, and Paul Scheihing for their support and guidance during this publication update project. Thanks are also due to Prakash Rao of Lawrence Berkeley National Laboratory (LBNL, Rolf Butters (AMO)) and to Vestal Tutterow of PPC for reviewing and providing publication comments.

The original motor sourcebook was prepared by technical staff at LBNL and the Resource Dynamics Corporation (RDC). The update was completed by technical staff at the Washington State University (WSU) Energy Program. Technical editing and graphic design were provided by the National Renewable Energy Laboratory (NREL). DOE, CDA, LBNL, RDC, WSU, and NREL wish to thank the many organizations that so generously assisted in data collection, and to acknowledge the helpful reviews and other contributions provided by the following individuals (those with bolded names participated in the update of this current Sourcebook edition):

Dale Basso, Rockwell Automation

Bruce Benkhart, Director, Applied Proactive Solutions

Thomas Bishop, P.E., Senior Technical Support Specialist,
Electrical Apparatus Service Association (EASA)

Austin Bonnett, EASA

Rob Boteler, Director of Marketing, Nidec Motor Corporation

Dennis Bowns, Bowns & Co.

Dave Brender, National Program Manager,
Electrical Applications, CDA

Wally Brithinee, Brithinee Electric

Kitt Butler, Director, Motors and Drives, Advanced Energy

John Caroff, Marketing Manager for Low Voltage Motors,
Siemens Industry, Inc.

Don Casada, Diagnostic Solutions

Jasper Fischer, Industrial Motor Repair

Ken Gettman, National Electrical
Manufacturers Association (NEMA)

William Hoyt, Industry Director, NEMA

John Kueck, Oak Ridge National Laboratory

John Machelor, Motor-Vations, LLC

John Malinowski, Senior Project Manager, Baldor Electric Co.

Ilene Mason, Consortium for Energy Efficiency

Gilbert McCoy, Energy Systems Engineer, WSU
Energy Program

Sally McNerney, University of Alabama

Cynthia Nyberg, EASA

Howard W. Penrose, Ph.D., Engineering and Reliability
Services, Dreisilker Electric Motors

Linda Raynes, President and CEO, EASA

Tim Schumann, SEW-Eurodrive

Charles Straub, P.E., Marathon Electric

Edward J. Swann, Rockwell Automation

John Tolbert, Bristol Compressor

Chuck Yung, EASA

Prepared for the U.S. Department of Energy
Office of Energy Efficiency and Renewable Energy
Advanced Manufacturing Office

By
Lawrence Berkeley National Laboratory
Berkeley, California

Resource Dynamics Corporation
McLean, Virginia

Washington State University Energy Program
Olympia, Washington

Produced by the National Renewable Energy Laboratory
Golden, Colorado

Cover photo from iStock 13079160

CONTENTS

GLOSSARY	iv
ACRONYMS	viii
QUICK START GUIDE	1
SAFETY CONSIDERATIONS	2
SECTION 1: MOTOR AND DRIVE SYSTEM BASICS	3
Overview	3
A Systems Approach	3
Indications of Poor System Design	4
Types of Electric Motors	4
Motor Operating Characteristics	9
Matching Motors and Drives to Their Applications	13
Load-Duty Cycles	17
Common Motor Selection Problems	17
Summary	19
SECTION 2: PERFORMANCE OPPORTUNITY ROAD MAP	21
Overview	21
Efficiency Opportunity No. 1: Assessing Motor and Drive System Operating Conditions	21
Efficiency Opportunity No. 2: Establishing a Motor Management Program	24
Efficiency Opportunity No. 3: Providing Basic Maintenance	27
Efficiency Opportunity No. 4: Selecting the Right Motor	31
Efficiency Opportunity No. 5: Using Variable Frequency Drives	37
Efficiency Opportunity No. 6: Addressing In-Plant Electrical Distribution and Power Quality Issues	40
Efficiency Opportunity No. 7: Using the Service Center Evaluation Guide	45
SECTION 3: MOTOR SYSTEM ECONOMICS	47
Overview	47
Understanding Corporate Priorities	47
Measuring the Economic Impact of Efficiency Improvements	47
Presenting the Finances of Efficiency	48
Relating Efficiency to Corporate Priorities	48
Summary	51
SECTION 4: WHERE TO FIND HELP	53
Advanced Manufacturing Office (AMO) Overview	53
Federal Energy Management Program (FEMP)	56
Directory of Contacts	56

Other Resources and Tools	58
Publications	59
Software and Tools	67
Additional Websites of Interest	67
Periodicals	68
Training Courses	68

APPENDICES 69

Appendix A: Motor Systems Energy Tip Sheets	71
Appendix B: Minimum Full-Load Efficiency Standards for Energy-Efficient and Premium Efficiency Motors	73
Appendix C: Motor Repair Service Center Checklist	77
Documents and Record Keeping	81

FIGURES

Figure 1. Types of motors	5
Figure 2. Induction motor	7
Figure 3. Squirrel-cage rotor	7
Figure 4. Typical motor part-load efficiency curve	9
Figure 5. Typical NEMA Design B induction motor speed-torque curve	11
Figure 6. Effect of speed reduction on the power used by a pump	13
Figure 7. Energy losses in a pump system when a throttle valve controls flow	14
Figure 8. Energy losses in a pump system when an ASD controls flow	14
Figure 9. Typical fan and system curves	15
Figure 10. LDC—example 1	17
Figure 11. Vector representation of power factor	18
Figure 12. LDC—example 2	23
Figure 13. Typical AC polyphase motor efficiency vs. load (1,800 rpm)	33
Figure 14. Torque and speed characteristics of various types of motors	34
Figure 15. Waveform distorted by harmonic effects	43

TABLES

Table 1. Common Inspection Tasks	29
Table 2. Sources of Motor Losses	33
Table 3. Common Types of Enclosures	36
Table B-1. Nominal Efficiencies for Open Drip-Proof Induction Motors Rated 600 V or Less	74
Table B-2. Nominal Efficiencies for Totally Enclosed Fan-Cooled Induction Motors	75
Table B-3. Nominal Efficiencies for Open Drip-Proof Induction Motors Rated 5 kV or Less	76
Table B-4. Nominal Efficiencies for Totally Enclosed Fan-Cooled Induction Motors Rated 5 kV or Less	76

GLOSSARY

Here are some of the principal terms associated with motor and drive systems; these terms appear in bold italicized type when they are first mentioned in the text. For more, please see the *IEEE Standard Dictionary of Electrical and Electronics Terms*¹.

adjustable speed drive (ASD) – An electric drive designed to provide easily operable means for speed adjustment of the motor, within a specified speed range.

air gap – A separating space between two parts of magnetic material, the combination serving as a path for magnetic flux. Note: This space is normally filled with air or hydrogen and represents clearance between rotor and stator of an electric machine.

alternating current (AC) – A periodic current the average value of which over a period is zero. (Unless distinctly specified otherwise, the term refers to a current that reverses at regular recurring intervals of time and that has alternately positive and negative values.)

ambient – Immediate surroundings or vicinity.

Ampere (A) – A unit of electric current flow equivalent to the motion of 1 coulomb of charge or 6.24×10^{18} electrons past any cross section in 1 second.

armature – The member of an electric motor in which an alternating voltage is generated by virtue of relative motion with respect to a magnetic flux field. In direct-current universal, alternating-current series, and repulsion-type motors, the term is commonly applied to the entire rotor.

balancing – The process of adding (or removing) weight on a rotating part to move the center of gravity toward the axis of rotation.

bars – Axial conductors in a rotor cage.

bearing losses – The power losses resulting from friction in the bearings.

best efficiency point – The operating condition at which a device operates most efficiently.

brake horsepower – Mechanical energy consumed at a rate of 33,000 foot-pounds per minute; a consumption rating.

breakaway torque – The torque that a motor is required to develop to break away its load from rest to rotation.

breakdown torque – The maximum shaft-output torque that an induction motor (or a synchronous motor operating as an induction motor) develops when the primary winding is connected for running operation, at normal operating temperature, with rated voltage applied at rated frequency. Note: A motor with a continually increasing torque, as the speed decreases to a standstill, is not considered to have a breakdown torque.

brushes – A conductor, usually composed in part of some form of the element carbon, serving to maintain an electric connection between stationary and moving parts of a machine or apparatus. Note: Brushes are classified according to the types of material used, as follows: carbon, carbon-graphite, electrographite, graphite, and metal-graphite.

British thermal unit (Btu) – The heat required to raise the temperature of 1 pound of water by 1°F. The Btu/hour required to raise the temperature of a volume of standard air a specific number of degrees is calculated by the formula: $\text{Btu/hour} = (\text{temperature rise}) \times [\text{cubic feet per minute (cfm)}] \times 1.085$.

burnout oven – Heat-cleaning oven used for stripping windings from a core. These are sometimes called roasting ovens. They operate at temperatures up to 750°F and may have water-spray systems to control temperature transients and secondary combustion to control emissions. They are distinguished from lower temperature baking ovens, which are used to cure varnish.

cage – See “squirrel cage.”

¹<http://ieeexplore.ieee.org/stamp/stamp.jsp?arnumber=04157151>

GLOSSARY

capacitor – A device, the primary purpose of which is to introduce capacitance into an electric circuit. Capacitors are usually classified, according to their dielectrics, as air capacitors, mica capacitors, paper capacitors, etc.

coil – One or more turns of wire that insert into a single pair of core slots.

cooling fan – The part that provides an airstream for ventilating the motor.

commutator – An assembly of conducting members insulated from one another, in the radial-axial plane, against which brushes bear, used to enable current to flow from one part of the circuit to another by sliding contact.

compressor – A device that increases the pressure of a gas through mechanical action. Compressors are used to provide a compressed air system to facilities and in mechanical vapor compression systems to provide cooling and refrigeration.

consumption – The amount of energy used by a motor system, measured in kilowatt-hours

core – The magnetic iron structure of a motor's rotor or stator. It is comprised of stacked sheet iron.

core losses – The power dissipated in a magnetic core subjected to a time-varying magnetizing force. Note: Core loss includes hysteresis and eddy-current losses of the core.

corrosion – The deterioration of a substance (usually a metal) because of a reaction with its environment.

curve, performance – A graphic representation of pressure and flow for a pump or a fan.

curve, system – A graphic representation of the pressure versus flow characteristics of a given system.

demand – The electric load integrated over a specific interval of time.

demand charge – That portion of the charge for electric service based upon a customer's demand.

direct current (DC) – A unidirectional current in which the changes in value are either zero or so small that they may be neglected. (As ordinarily used, the term designates a practically non-pulsing current.)

eddy-current coupling – A type of adjustable speed drive that changes the strength of a magnetic field in a coupling to determine the amount of slip between the motor and the driven equipment.

efficiency – The ratio of the useful output to the input (energy, power, quantity of electricity, etc.). Note: Unless specifically stated otherwise, the term "efficiency" means efficiency with respect to power.

foot-pound (ft-lb) – Torque rating or requirement; equivalent to the force required to move a 1-pound weight 1 foot in distance, equal to 12- inch-lbs.

frame size – A set of physical dimensions of motors as established by National Electrical Manufacturers Association for interchangeability between manufacturers. Dimensions include shaft diameter, shaft height, and motor-mounting footprint.

frequency – The number of periods per unit time.

friction/windage losses – The power required to drive the unexcited motor at rated speed with the brushes in contact, deducting that portion of the loss that results from: (1) forcing the gas through any part of the ventilating system that is external to the motor and cooler (if used); and (2) the driving of direct-connected flywheels or other direct-connected apparatus.

full-load speed – The speed that the output shaft of the drive attains with rated load connected and with the drive adjusted to deliver rated output at rated speed. Note: In referring to the speed with full load connected and with the drive adjusted for a specified condition other than for rated output at rated speed, it is customary to speak of the full-load speed under the (stated) conditions.

full-load torque – The torque required to produce the rated horsepower at full-load speed.

GLOSSARY

harmonics – A sinusoidal component of a periodic wave or quantity having a frequency that is an integral multiple of the fundamental frequency. Note: For example, a component the frequency of which is twice the fundamental frequency is called the second harmonic.

hertz (Hz) – Unit of frequency, one cycle per second.

high-potential test – Test of insulation integrity by application of a higher than nameplate rated alternating-current or direct-current voltage between electrical winding or circuit elements and ground. Also called a “hi pot test.”

horsepower (hp) – A measure of the amount of the work a motor can perform in a period of time, 33,000 foot-pounds per minute or 0.746 kilowatt.

induction motor – The simplest and, by far, most commonplace alternating-current motor design. The induction motor rotor is simple, having neither permanent magnets, externally excited electromagnets, nor salient (projecting) poles. The rotor contains a conducting structure, which is excited by magnetic induction from the stator without necessity of brushes or other direct contact.

inertia – Tendency of an object to remain in the state it is in. For motors, inertia generally refers to the resistance of the rotor, coupling, and load to acceleration.

insulation – Material or a combination of suitable nonconducting materials that provide isolation of two parts at different voltages.

inverter duty – Intended for being powered by a direct-current to alternating-current inverter. An inverter comprises the output stage of all electronic adjustable speed drives, which are also known as variable speed drives or variable frequency drives. Part 31 of the National Electrical Manufacturers Association MG-1 provides recommended standards for inverter-duty motors.

inverter – A machine, device, or system that changes direct-current power to alternating-current power.

journal – Region on a shaft where a bearing is located. The journal must be precisely machined for a correct fit to the bearing bore. With sleeve bearings, the journal is the actual bearing surface on the shaft.

kilowatt – A measure of power equal to 1.34 horsepower; 1,000 watts.

load factor – The ratio of the average load over a designated period of time to the peak load occurring in that period.

locked-rotor torque – The minimum torque of a motor that is developed upon startup for all angular positions of the rotor, with rated voltage applied at rated frequency.

losses – Motor input power that is lost rather than being converted to shaft power. The lost power manifests as heat in various parts of the motor structure.

low voltage – Voltage ratings not exceeding 600-volt alternating current.

poles – The total number of magnetic north/south poles produced in the rotating magnetic field of a motor. The number of poles is determined by the winding design, and the motor speed is inversely related to the number of poles.

Polyphase – A polyphase system usually has three energized *electrical conductors* (a three-wire system) carrying alternating currents with a *time offset* between the voltage waves in each conductor. Polyphase systems are particularly useful for transmitting continuous power to *electric motors*.

resistance, insulation – Resistance between points that are supposed to be electrically isolated.

resistance, winding – Resistance of the winding measured between each pair of line connections. Rewinding should replicate original resistance. Changed resistance after rewinding may indicate an altered winding pattern, incorrect wire gauge, or a turn miscount.

rotor – The rotating part of an alternating-current induction motor that includes the shaft, the laminated iron, and the squirrel cage.

rotor losses – The losses due to current flow in the rotor circuit (equal to I^2R where I is the current in the rotor and R is the resistance of the rotor circuit).

service factor – A multiplier that, when applied to the rated power, indicates a permissible power loading that may be carried under the conditions specified for the service multiplier.

single phase – A power system defined by having an AC source with only one voltage waveform.

GLOSSARY

slip – The quotient of (A) the difference between the synchronous speed and the actual speed of a rotor to (B) the synchronous speed, expressed as a ratio or as a percentage.

squirrel cage – This is the current-conducting assembly used in most induction motor rotors. Sometimes called a “rotor cage.” It is typically cast aluminum in smaller motors and fabricated of copper alloy in larger motors.

separators – Insulating spacers used to separate coils of separate phases within a slot. Also called “slot sticks.”

stator – The stationary part of a motor’s magnetic circuit. In induction motors, it is the outer annular iron structure containing the power windings.

stator losses – Losses due to the flow of current through the stator windings, (equal to I^2R , where “I” is the stator current and “R” is the resistance of the stator circuit).

stray-load losses – The losses due to eddy currents in copper and additional core losses in the iron, produced by distortion of the magnetic flux by the load current, not including that portion of the core loss associated with the resistance drop.

surge – A transient wave of current, potential, or power in an electrical circuit.

synchronous speed – The speed of the rotation of the magnetic flux, produced by or linking the primary winding.

temperature rise – Temperature increase above ambient. National Electrical Manufacturers Association provides standards for temperature rise of fully loaded motors based upon insulation class and other motor parameters.

three-phase – Commonplace alternating-current electrical service involving three conductors offset in phase from each other. The concept eliminates torque pulsation and accommodates creation of rotating magnetic fields within motors to facilitate starting and running torque.

torque – A force that produces rotation, commonly measured in foot-pounds.

transients – A change in the steady-state condition of voltage or current, or both. variable frequency drive (VFD) – A type of adjustable speed drive that changes the frequency of the electric power supplied to a motor. Because motor speed is linearly related to electrical frequency, these devices directly control motor rotation, avoiding the need for an intermediate coupling between the motor and the driven equipment.

watt (W) – The unit of power in the International System of Units (SI). The watt is the power required to do work at the rate of 1 joule per second.

windings – An assembly of coils designed to act in consort to produce a magnetic-flux field or to link a flux field.

wireless sensors – Electronic means of value measurement and transmission that can provide diagnostic or trending information for predictive and preventative maintenance prior to failure.

ACRONYMS

A	amp(s) or ampere(s)	ISO	International Organization of Standardization
ABMA	American Bearing Manufacturers Association	ITP	Industrial Technologies Program (now AMO)
AC	alternating current	kW	kilowatt(s)
AMO	Advanced Manufacturing Office	kWh	kilowatt-hour(s)
ANSI	American National Standards Institute	kVA	kilovolt-ampere(s)
ASD	adjustable speed drive	LBNL	Lawrence Berkeley National Laboratory
Btu	British thermal unit(s)	LCC	life cycle cost
CDA	Copper Development Association	LDC	load-duty cycle
CEE	Consortium for Energy Efficiency	NEEA	Northwest Energy Efficiency Alliance
cfm	cubic feet per minute	NEMA	National Electrical Manufacturers Association
DC	direct current	NO_x	oxides of nitrogen
DOE	U.S. Department of Energy	NREL	National Renewable Energy Laboratory
EASA	Electrical Apparatus Service Association	NxEAT	NO _x and Energy Assessment Tool
ECPM	electronically commutated permanent magnet	P/E	price-to-earnings
EE	energy efficiency	PHAST	Process Heating Assessment and Survey Tool
EISA	Energy Independence and Security Act	PM	permanent magnet
EMD	electrical motor diagnostics	PPM	preventive and predictive maintenance
EMI	electromagnetic interference	PSAT	Pumping System Assessment Tool
EPAct	Energy Policy Act	PWM	pulse-width modulation
EPRI	Electric Power Research Institute	RDC	Resource Dynamics Corporation
FEMP	Federal Energy Management Program	RPM	revolutions per minute
FFT	fast Fourier transform	SR	switched reluctance
FSAT	Fan System Assessment Tool	SSAT	Steam System Assessment Tool
ft	foot	THD	total harmonic distortion
ft-lb	foot-pound	TVSS	transient voltage-surge suppression
HID	high-intensity discharge	UL	Underwriters Laboratories
hp	horsepower	UPS	uninterruptible power supply
hr	hour	V	volt(s)
HVAC	heating, ventilating, and air conditioning	VFD	variable frequency drive
Hz	hertz	VSD	variable speed drive
IEC	International Electrical Commission	W	watt(s)
IEEE	Institute of Electrical and Electronic Engineers	Wk2	load inertia
in-wg	inches of water gauge	WSU	Washington State University
IR	infrared		

QUICK START GUIDE

This sourcebook is designed to provide those who use motor and drive systems with a reference that outlines opportunities to improve system performance. It is not meant to be a comprehensive technical text on motor and drive systems; rather, it provides practical guidelines and information to make readers aware of potential performance improvements. Guidance on how to find more information and assistance is also included.

Plant engineers, facility managers, operations personnel, maintenance staff, and those involved in the procurement of motors and adjustable speed drive systems will find this sourcebook helpful in assessing the efficiency of their motor and drive applications. Discussions of efficiency improvement opportunities in this sourcebook emphasize the connection between operating efficiency and system reliability. For example, a plant project that increases the overall efficiency of a motor and drive system often reduces plant downtime, as well. This is one of several important benefits of efficiency improvements.

This sourcebook is divided into four main sections, as outlined below.

Section 1: Motor and Drive System Basics

For readers who are unfamiliar with the basics of motor and drive systems or would like a refresher, this section briefly describes important terms, relationships, and system design considerations. It also describes key factors involved in motor and drive selection and system design, and provides an overview of the different types of motors and drives and their applications. Readers who are already familiar with key terms and parameters used in selecting motors and drives, designing systems, and controlling their operation might want to skip this section and go on to the next one.

Section 2: Performance Opportunity Road Map

This section describes the key components of a motor and drive system as well as opportunities for performance improvements. A systems approach is emphasized, rather than a focus on individual components. Guidance is provided as a set of efficiency opportunities, which cover the following topics in separate subsections for easy reference:

- Assessing Motor and Drive System Operating Conditions
- Establishing a Motor Management Program
- Providing Basic Maintenance

- Selecting the Right Motor
- Using Adjustable Speed Drives
- Addressing In-Plant Electrical Distribution and Power Quality Issues
- Using the Service Center Evaluation Guide.

Section 3: Motor System Economics

This section provides recommendations on how to propose projects like those described in Section 2 by highlighting the favorable economics of motor and drive system improvements to management. Topics include understanding and identifying corporate priorities, relating those priorities to efficiency, and clarifying the financial aspects of efficiency improvements, including life cycle costs and payback periods.

Section 4: Where to Find Help

Section 4 provides a directory of associations and other organizations associated with motors and drives and motor-driven equipment. This section also lists helpful resources for additional information, tools, software, videos, and training opportunities.

Appendices

This sourcebook contains three appendices:

Appendix A

Contains a listing of motor and drive system “Energy Tips” sheets. Developed by the U.S. Department of Energy’s Advanced Manufacturing Office, these tip sheets discuss opportunities for improving the efficiency and performance of motor systems, but in less detail than the efficiency opportunities described in Section 2.

Appendix B

Provides minimum full-load efficiency standards for energy-efficient and premium efficiency motors. They are extracted from Table 12-11 and Table 12-12 of the National Electrical Manufacturers Association’s (NEMA’s) publication NEMA MG 1-2011 *Motors and Generators*.

Appendix C

Includes a checklist for use when evaluating the capabilities of and selecting your motor service center.

SAFETY CONSIDERATIONS

This sourcebook discusses the types of measurements an electrician has to take. It is not intended to be an instruction manual on how to be an electrician nor a training manual on proper safety techniques. The assumption is that instructions will be followed by qualified electricians who are trained in safety practices relating to industrial electrical systems. Personnel who are not qualified or trained in industrial electrical techniques should not attempt to take any measurements.

SECTION 1: MOTOR AND DRIVE SYSTEM BASICS

Overview

Electric motors, taken together, make up the single largest end use of electricity in the United States. In the U.S. manufacturing sector, electric motors used for machine drives such as pumps, conveyors, compressors, fans, mixers, grinders, and other materials handling or processing equipment account for about 54% of electricity consumption. Additional energy is consumed in HVAC and refrigeration equipment. Electric motors provide efficient, reliable, long-lasting service, and most require comparatively little maintenance. Despite these advantages, however, they can be inefficient and costly to operate if they are not properly selected and maintained. Industrial plants can avoid unnecessary increases in energy consumption, maintenance, and costs by selecting motors that are well suited to their applications and making sure that they are well maintained.

A Systems Approach

Cost-effective operation and maintenance of a motor and drive system requires attention not just to individual pieces of equipment but to the system as a whole. A systems approach analyzes both the supply and demand sides of the system and how they interact, essentially shifting the focus from individual components to total system performance. Operators can sometimes be so focused on the immediate demands of their equipment that they overlook the ways in which the system's parameters are affecting that equipment.

A common engineering approach is to break down a system into its basic components or modules, optimize the selection or design of those components, and then assemble the system. An advantage of this approach is that it is simple. A disadvantage is that this approach ignores the interaction of the components. For example, sizing a motor so that it is larger than necessary—essentially giving it a safety factor—ensures that the motor can provide enough **torque** to meet the needs of the application. However, an oversized motor can create performance problems with the driven equipment, especially in turbomachinery such as fans or pumps. In certain circumstances, an oversized motor can compromise the reliability of both the components and the entire system.

In a component approach, the engineer employs a particular design condition to specify a component. In a systems approach, the engineer evaluates the entire system to determine how end-use requirements can be provided most effectively and efficiently. Focusing on systems means expanding possibilities, from looking for one piece of equipment that can meet worst-case requirements to evaluating whether components can be configured to maintain high performance over the entire range of operating conditions.

A basic premise of a systems approach is that industrial systems usually do not operate under one condition all the time. Motor and drive system loads often vary according to cyclical production demands, environmental conditions, changes in customer requirements, and so on. To optimize system performance, the engineer must configure the system to avoid inefficiencies and energy losses. For example, motors that typically run at more than one-half to full load usually operate much more efficiently than they do at less than one-half load or into their service factor. The service factor of an **alternating-current (AC)** motor is a multiplier which, when applied to the rated motor **horsepower (hp)**, indicates a permissible loading for operation under usual service conditions. Though operation within the service factor is permissible, it is not recommended because a motor operating at any service factor greater than 1 will have a reduced life expectancy. Common service factor values are 1.10 and 1.15. Other avoidable losses occur when throttling valves or dampers are used for flow regulation.

For example, suppose that a motor-driven pump supplies water to several heat exchangers and has a flow requirement that the system piping and heat exchangers were designed to handle. The pump was specified according to the requirements of this flow condition. However, actual operating conditions can vary according to the season, the time of day, and the production rate. To handle the need for variable flow rates, the system is equipped with throttling valves and recirculation bypass lines. This equipment provides the desired flow regulation, but at the expense of wasted energy.

Similarly, many fan systems have variable air-delivery requirements. A common practice is to size the fan so that it meets the highest expected load and use inlet guide vanes or discharge dampers to restrict airflow during periods of low demand. However, one of the least efficient methods of controlling flow is to use discharge dampers. Consequently, although the system provides adequate airflow, the lack of a drive to control the motor's speed (and thus airflow) can cause system operating costs to be significantly higher than necessary.

In addition to increasing energy costs, an inefficient motor and drive system often increases maintenance costs. When systems do not operate efficiently, thermal and mechanical energy losses must be dissipated by piping, structures, dampers, and valves. Additional system stresses can accelerate wear and create loads for which the system was not originally designed. For example, in a pumping system, excess flow energy must be dissipated across throttle valves or through bypass valves, or it must be absorbed by the piping and support structure. As a result, all of this equipment can degrade more easily. Throttle and bypass valves can require seat repair, and piping and support structures can develop cracks and leak as a result of fatigue loads. Repairing or replacing this equipment can be costly.

In addition, inefficient system operation in an industrial plant can create poor working conditions such as high levels of noise and excessive heat. High noise levels can be the result of flow noise, structural vibrations, or simply normal equipment operation. In addition, inefficient systems often add heat to the workplace. This added heat often must be removed by the facility's heating, ventilating, and air-conditioning (HVAC) system, further increasing total operating costs.

Indications of Poor System Design

Taking a component-based approach to industrial system design and operation tends to increase facility costs and maintenance requirements, and reduce reliability. However, the problems associated with a poorly designed system—high energy costs, the need for frequent maintenance, and poor system performance—can be corrected, as indicated in the following paragraphs.

High Energy Costs

High energy costs can be the result of inefficient system design as well as inefficient motor operation. Not selecting or designing a proper motor and drive system for the application can also lead to power quality problems, such as voltage sags, harmonics, and a low-power factor.

Frequent Maintenance

Equipment that is not properly matched to the requirements of the application tends to need more maintenance. The primary causes of increased maintenance requirements are the added stresses on the system and the increased heat that accompanies inefficient operation. Ironically, system designers often specify oversized motors, drives, and end-use equipment to improve reliability. An oversized motor might be more reliable, but it might also make other parts of the system less reliable. A more effective way of ensuring high reliability is to design a system and specify system components so that the system's operating efficiency is high over the full range of operating conditions.

Poor System Performance

Operating a motor and drive system that was not properly selected for its application can result in poor overall system performance. Poor system performance is a major cause of increases in maintenance and decreases in reliability. Common indications include abrupt or frequent system starts and stops, high noise levels, and hot work environments. In many material handling systems, the work-in-process moves roughly from one work station to the next. The banging that often accompanies sudden accelerations and decelerations is symptomatic of stress on the motor and drive system. The consequences of this stress can be more frequent maintenance and poor operating efficiency.

High noise levels due to cavitation or recirculation flows are common in fluid systems with oversized or misapplied pumps. Because energy losses in fluid flow often dissipate as noise, systems with large flow losses tend to be loud.

Types of Electric Motors

To ensure that motors are applied properly, it is essential to understand the various types of motors and their operating characteristics. Electric motors fall into two classes, based on the power supply: AC or *direct current (DC)*. The most common types of industrial motors are shown in Figure 1.

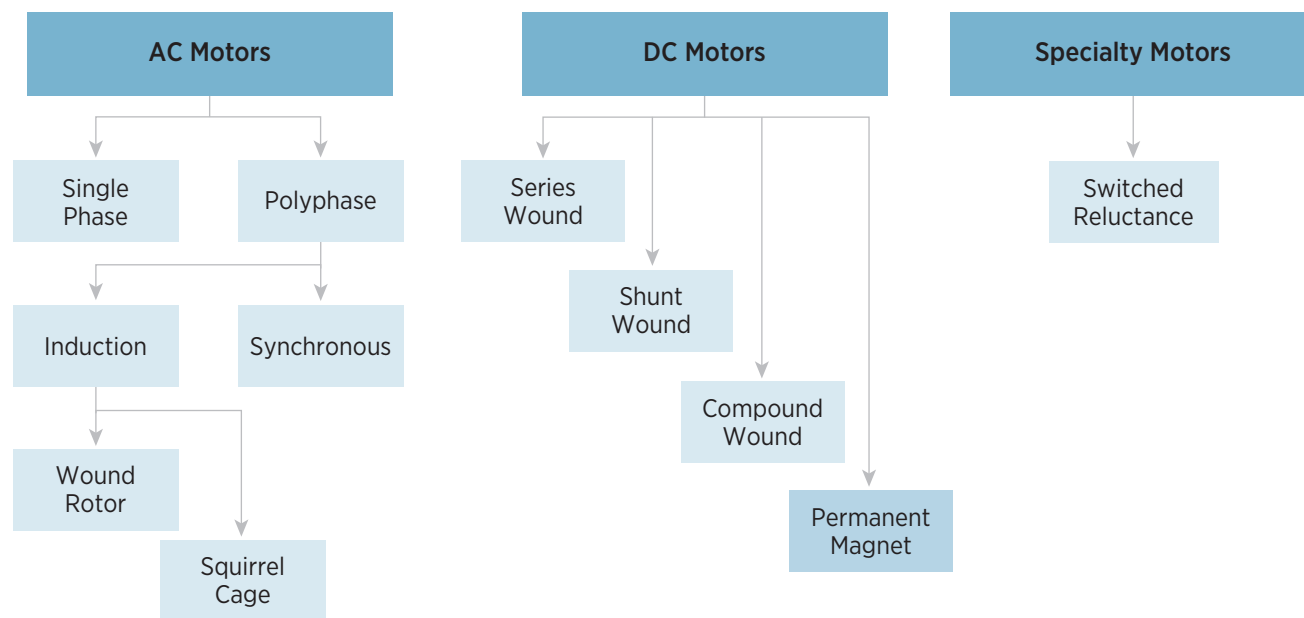

Figure 1. Types of motors

AC motors can be single-phase or polyphase. In terms of quantity, single-phase motors are the most common type, mainly because many small motors are used for residential and commercial applications in which single-phase power is readily available. However, several operating constraints on these motors limit their widespread use in industrial applications. Integral single-phase induction motors tend to pull large, starting currents relative to the motor’s size. In general, they operate less efficiently than three-phase motors of comparable size, and are not available in a wide range of synchronous speeds or in ratings above 15 hp.

In contrast, polyphase motors are used widely in industrial applications. Polyphase motors can be found in almost every industrial process, and they often operate continuously to support production processes. These motors can achieve high efficiencies with favorable torque and current characteristics. The effectiveness and low cost of three-phase motors are major reasons why three-phase power is used so widely in industry. In terms of energy consumption and efficiency improvement opportunities, three-phase motor systems predominate. Therefore, they are the main focus of this sourcebook.

Direct-Current Motors

DC power was central to Thomas Edison’s vision of how electricity should be supplied. Because of their competitive advantages, however, AC power and AC motors soon became the industry favorite. Despite the predominance of three-phase AC motors, DC power has advantages in certain industrial applications and is still widely used.

The advantages of DC motors include excellent speed control and the ability to provide high torque at low speeds. However, a majority of DC motors use brushes to transfer electrical power to the motor armature. Brush assemblies not only require a larger motor, they can also increase maintenance requirements. As brushes wear, they create a housekeeping problem by generating carbon dust. Brushes are also sensitive to contamination, especially in machines that contain silicone materials, and they must be replaced periodically.

Because electric power is supplied as AC, additional equipment that generates DC power, such as motor generator sets or silicon-controlled rectifier controls, are needed to run DC machines. Small electronically commutated permanent-magnet (ECPM) or brushless-DC motors provide variable speed capability and are in widespread use in low

horsepower, general purpose applications. Because batteries supply direct current, DC motors have an advantage in applications in which the motor is supplied by a DC bus as part of an uninterruptible power system. Although these applications are somewhat specialized, they could increase as industry becomes more sensitive to power quality problems and more aware of the high cost of interruptions in production.

There are four principal classes of DC motors: series wound, shunt wound, compound wound, and permanent magnet. Series-wound, shunt-wound, and compound-wound motors all require brushes to supply current to the stator. The differences between these motors are based on how the stator (field frame) and the rotor (armature) are connected.

Series Motor. In a series motor, as the name implies, the fields and armature are connected in series, and the same current passes through both. In this configuration, torque increases in proportion to the square of the increase in current. This relationship is true until the magnetic strength of the motor is reached, which is a condition known as saturation. Beyond saturation, any load increase is directly proportional to an increase in current.

Compound Motor. A compound motor is a combination of a series- and a shunt-wound motor (a shunt-wound motor has field and armature circuits connected in parallel). A compound motor has two basic circuit branches: in one branch, a shunt-field circuit wraps around the stator, and in the other branch a series circuit includes both the series fields and the armature. A key operating characteristic of this type of motor is that it can handle sudden increases in loads without a great change in speed.

Permanent Magnet. Permanent-magnet (PM) motors rely on inherently magnetic materials—such as alloys of cobalt, nickel, iron, and titanium—to create a magnetic field. PM motors can range up to 600 hp in size. They can be constructed in several different ways, and some versions operate with AC power. However, most industrial PM motors are brushless DC types. An ECPM motor is a type of brushless-DC motor having speed and torque control. ECPM motors can use single-phase AC input power and convert it into three-phase operation. And ECPM motors use electromagnetic-force sensing to determine rotor position and perform the commutation function. Because of their design, ECPMs do not exhibit the brush wear and noise associated with typical DC motors.

PM motors have certain performance advantages over AC-induction motors, especially in applications with wide variations in load and speed. PM motors can maintain relatively high efficiencies at low motor loads and, like other DC motors, they can provide high torque at low motor speeds. Because they do not require brushes, using PM motors avoids many of the operating and maintenance problems normally associated with DC motors. Advances in PM motor technology have made this type competitive with the more commonly used induction motor/*variable frequency drive (VFD)* combination, in many applications. A drawback of PM motors is their tendency to accumulate magnetic contaminants, even when the motor is idle.

Alternating-Current Motors

AC motors are the most widely used in the industry. Industry’s preference for AC motors springs from their simplicity, low cost, and efficiency. There are two primary types of AC motors: induction (also referred to as asynchronous) and synchronous. With the exception of wound-rotor motors that have slip rings, the rotors of induction motors are not physically connected to any external circuits; instead, the excitation current is induced by a magnetic field. In synchronous rotors, the excitation current is fed directly to the rotor by means of brushes and slip rings or a rectifier bridge (brushless excitation). Induction motors are widely used because of their simple design, rugged construction, relatively low cost, and characteristically long operating life. Synchronous motors, on the other hand, have some useful advantages and are used in more specialized applications.

In both types of motors, the stator circuit creates a magnetic field that rotates at a *synchronous speed*. This speed depends on the number of *poles* and the *frequency* of the electricity supply; and it is determined by the following equation:

$$\text{Synchronous speed} = \frac{120 \times \text{frequency [hertz (Hz)]}}{\text{number of poles}}$$

For example, in a 60-Hz system, the stator field in a two-pole motor rotates at 3,600 revolutions per minute (RPM), the field in a four-pole motor rotates at 1,800 RPM, and the field in a six-pole motor rotates at 1,200 RPM.

An important operating difference between induction motors and synchronous motors is that induction motors operate at somewhat less than synchronous speed. The difference between the actual speed and synchronous speed is known as *slip*. Synchronous motors operate without slip at synchronous speed.

Induction Motors. Induction motors include squirrel-cage and wound-rotor types. Induction motors rely on a magnetic field to transfer electromagnetic energy to the rotor. The induced currents in the rotor create a magnetic field that interacts with the stator field. The speed of the rotor’s magnetic field is slightly less than that of the stator (this difference is the slip). As the load on the motor increases, the slip also increases. The full-load speed is typically shown on the motor nameplate. A typical induction motor is shown in Figure 2.

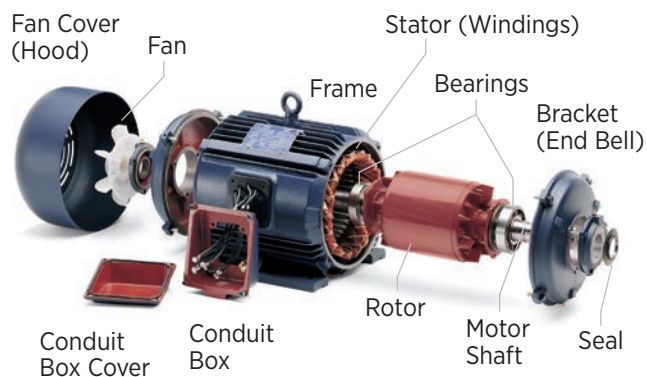

Figure 2. Induction motor
Illustration from Leeson Electric Corporation

Squirrel-Cage Motors. The most common type of industrial motor is the squirrel-cage induction motor. The name derives from the similarity between the rotor and the type of wire wheel commonly found in pet cages at the time this motor was first developed (see Figure 3). Rotor bars are either welded or cast to two circular end rings, forming a circuit with very little resistance.

Advantages of this type of motor include the following:

- Low cost
- Low maintenance
- High reliability
- A fairly wide range of torque and slip characteristics.

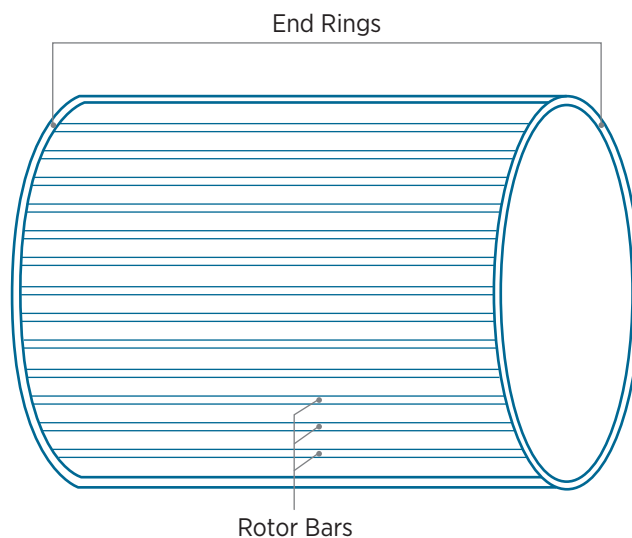

Figure 3. Squirrel-cage rotor

Because squirrel-cage induction motors can be designed and built to have a relatively wide range of torque and slip characteristics, the National Electrical Manufacturer Association has developed a set of classifications for these motors. These classifications help engineers and designers select the right motors for applications that require certain starting torques, operating torques, and slip rates. For more on these motor classifications, see “Efficiency Opportunity No. 4: Selecting the Right Motor” in Section 2 of this sourcebook.

Wound-Rotor Motors. Another type of induction motor is the wound rotor. In this type, either bars are inserted into the rotor or wires are wound into slots in the rotor. In wound rotors, current is induced in the rotor, and the resistance of the rotor circuit is varied by adding or removing external resistance to control torque and speed. An important operating characteristic of these motors is the ability to adjust speed and torque characteristics by controlling the amount of resistance in the rotor circuit.

Characteristics of this type of motor include the following:

- Excellent speed control
- High-starting torque
- Low-starting current
- Ability to handle high-*inertia* loads (squirrel-cage induction motor slip losses would be too large and could overheat rotors)
- Ability to handle frequent starts and stops
- Ability to operate at reduced speeds for long periods.

Synchronous Motors. These motors, as their name implies, operate at the same speed as the rotating magnetic field. Although they are more expensive to purchase and maintain, they can be 1% to 2% more efficient—depending on motor size—than induction motors. They can also add a leading power factor component to a distribution system, which makes them attractive to many industrial facilities. In fact, synchronous motors are occasionally operated without a load, as synchronous condensers, just to increase a facility’s power factor.

In industrial synchronous motors, an external supply of DC power is usually supplied to the rotor by a set of slip rings and brushes. In newer models, brushless excitation systems and PM generators are built into the rotor. Because the direct current does not change the polarity, the rotor needs a separate squirrel-cage winding during starts. But once the rotor approaches operating speed, the squirrel-cage winding becomes inoperative; as the direct current is applied, the rotor speed is pulled into synchronicity with the rotating magnetic field created by the stator.

Switched-Reluctance Motors. Switched-reluctance (SR) motors have several performance, efficiency, and cost advantages that should encourage their use in an increasing number of applications. SR motors do not have magnets or rotor *windings*. Their simple, rugged design also provides higher reliability. Important advantages of SR motors include exceptional feedback and flexibility in speed and torque control.

SR motors operate much like an electromagnetic *coil*. The stator contains poles that, when energized, create a magnetic field that pulls the nearest pole on the rotor toward it. Consequently, the performance of SR motors is largely a function of the power electronics that control the sequencing of pole energizations. SR motors have characteristically high power-to-weight ratios and are well suited for vehicle applications. Their torque and speed-control characteristics also make them suitable for pump and fan applications in which power is highly sensitive to operating speed. In the past, the disadvantages of SR motors included torque ripple (pole-to-pole variations in torque) and higher operating noise; however, improvements have been made in these areas.

SR motor technology was initially developed in the 19th century, but limitations in power electronics technology made this type of motor impractical. Later developments in power electronics improved their performance and lowered their costs, increasing their applicability. However, the cost of the power modules often offsets the lower cost of the SR motor itself. The modules are relatively specialized, often generating four-phase power.

Improvements in power electronics have made both PM and SR motors and similar systems much more suitable for many applications. Despite the many advantages of these motor systems, the most common type of industrial motor is still the squirrel-cage induction type. Because motors are indispensable to plant operations, facilities tend to resist using a new motor technology if the current system is performing adequately. Adopting better operating practices or incorporating better controls into existing induction motor systems incurs less risk and can result in the same levels of efficiency and performance that new motor technologies exhibit. For additional information on PM and SR motors, see the “Advanced Motor Technologies” chapter in the U.S. Department of Energy (DOE) Advanced Manufacturing Office’s (AMO’s) *Premium Efficiency Motor Selection and Application Guide*.¹

¹www1.eere.energy.gov/manufacturing/tech_assistance/motors.html

Motor Operating Characteristics

The most important motor operating characteristics are horsepower, operating speed (measured in RPM), and torque. These are related by the following equation:

$$\text{hp} = \frac{\text{torque (ft - lb)} \times \text{RPM}}{5,252}$$

Motor performance depends on how well these operating characteristics match the load. The load on a motor is not always constant, and the response of the motor to changes in load is a fundamental factor in selecting the right motor for an application. For more on this, see “Efficiency Opportunity No. 4: Selecting the Right Motor” in Section 2 of this sourcebook.

Voltages

The motor voltage must match the rated system supply voltage. A mismatch between the motor voltage and the system voltage can result in severe operating problems and, in some cases, immediate failure. However, this type of problem is not common. Operating a motor when the system voltage varies significantly from its rated level is a more critical concern. And problems like these are often the result of a distribution system problem such as *three-phase* voltage unbalance, voltage outages, sags, *surges*, and overvoltage or undervoltage.

Motor performance is significantly affected when a motor operates at voltages $\pm 10\%$ or more from its rated voltage. See “Efficiency Opportunity No. 6: Addressing In-Plant Electrical Distribution and Power Quality Issues” in Section 2 of this sourcebook. A facility that experiences wide swings in voltage will probably have an abundance of power quality problems, including poor motor operation. If that is the case, the facility’s distribution system should be reviewed. For additional information on troubleshooting and tuning your in-plant distribution system, see “The Plant Electrical Distribution System” chapter in the AMO’s *Premium Efficiency Motor Selection and Application Guide*.²

²www1.eere.energy.gov/manufacturing/tech_assistance/motors.html

Horsepower

The horsepower rating of a motor indicates its brake or shaft horsepower output. A motor should be able to support the power requirements of the load without being oversized or undersized. The motor’s horsepower rating should ensure that the motor does not operate into its service factor or below 40% of full-load for long periods (see Figure 4). Motor torque and speed are important additional considerations in determining a motor’s ability to operate effectively and efficiently. The responsiveness of the motor in starting and operating is critical and should be considered concurrently with its horsepower.

Engineers should be careful not to oversize a motor just to satisfy a speed or torque requirement. Oversized motors tend to incur higher starter, protection, initial purchase, maintenance, and operating costs (including costs for power factor correction). A systems approach to motor selection is an effective way of ensuring adequate, cost-effective operation.

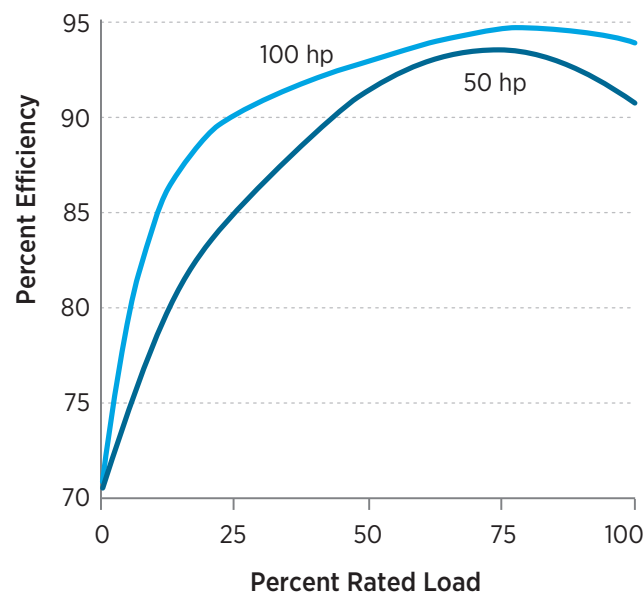

Figure 4. Typical motor part-load efficiency curve
(Adapted from A. Bonnet, *IEEE Trans.* 36:1, Fig. 26, Jan. 2000)

Speed

The speed of an electric motor is an important element that depends on many factors. The operating speed of a DC motor depends on the type of motor, the strength of the magnetic field, and the load. The operating speed of an AC motor depends on the rotor type, the number of poles, the frequency of the power supply, and slip characteristics. Synchronous AC motors operate at the speed of the rotating magnetic field; most induction motors operate within 1% to 3% of this speed, depending on the motor's slip characteristics.

Common AC motor synchronous speeds are 3,600, 1,800, 1,200, 900, and 600 RPM. Many applications require speeds different from these, however, so AC motors are usually combined with various types of speed adjustment devices. These devices include gears, belts, eddy-current couplings, hydraulic couplings, VFDs, etc. Two-speed AC motors can operate at multiple speeds by using separate windings within the same motor or by using a single winding with an external switch that changes the number of poles.

An important consideration is whether the speed must be constant or variable. In constant-speed applications, gears or belts can provide fixed-speed ratios between the motor and the driven equipment. Variable speed applications can be served by multiple-speed motors or drive systems with adjustable speed ratios. Belt and gear efficiency measures are discussed in the “System Efficiency Improvement Opportunities” chapter of AMO’s *Continuous Energy Improvement in Motor Driven Systems*.³

Adjustable Speed Motors. Many applications that are currently served by constant-speed motors are well suited for variable speed control. For example, in many pumping and fan system applications, flow is controlled by using restrictive devices such as throttling valves or dampers, or through the use of recirculation bypass methods. Although these flow-control methods have advantages, speed control is often a more efficient and cost-effective option for many systems.

Similarly, in many material handling systems, **adjustable speed drives** (ASDs) can increase system efficiency and improve system reliability. For example, in many conveyor systems, lines are controlled by energizing and de-energizing a series of motors. These frequent starts

and shutdowns are tough on motors and line components because of repeated stresses from starting currents, and acceleration and deceleration of mechanical components. Using ASDs can smooth out line motion for more efficient and effective operation.

Some motors have inherent speed control capabilities. For example, DC motors have excellent speed and torque control characteristics, and are often used when high torque at low speeds is required. The speed adjustments of DC motors can be as much as 20:1, and they can operate at 5% to 7% of the motor's base speed (some can even operate at 0 RPM). Some AC motors can also be used in speed adjustment situations. Wound-rotor motors can have speed ratios of as much as 20:1 by changing the resistance in the rotor circuit.

Another common method of controlling speed is to use induction motors combined with pulse-width modulated variable frequency drives (VFDs). Induction motors are widely used in industrial applications because of their inherent advantages in terms of cost, reliability, availability, and low maintenance requirements. Mechanics and operators are usually familiar with these motors, which facilitate repair and maintenance tasks.

Combining an in-service motor with a VFD provides facilities with an effective speed control technology that does not require the use of a different type of motor. However, not all in-service induction motors can be combined with a VFD; engineers should evaluate motors and load requirements on a case-by-case basis to see if such combinations are feasible. Misapplying VFDs to in-service motors can prevent expected energy savings from materializing, or can quickly cause motor failures. Moreover, some motor-driven machines have speed-dependent lubrication systems, and these must be considered in any assessment associated with changes in speed. For additional information on VFD retrofits, voltage overshoots, and bearing currents, refer to the “Motor Interactions with Adjustable Speed Drives” and “Inverter Duty Motor Design Features” sections of AMO’s *Premium Efficiency Motor Selection and Application Guide*.⁴

Induction motors with VFDs are increasingly being used in applications that once featured DC motors. Although DC motors still have some operating advantages in low-speed, high-torque applications, the added complexity associated with operating and maintaining a DC motor

³www1.eere.energy.gov/manufacturing/tech_assistance/motors.html

⁴www1.eere.energy.gov/manufacturing/tech_assistance/motors.html

system is an important factor behind the increasing numbers of induction motor/VFD systems. See “Efficiency Opportunity No. 5: Using Variable Frequency Drives” in Section 2 of this sourcebook. Also refer to AMO’s Energy Tips sheet *Minimize Adverse Motor and Adjustable Speed Drive Interactions*,⁵ and the “Use Adjustable Speed Drives for Applications with Variable Flow Requirements” section of AMO’s *Continuous Energy Improvement in Motor Driven Systems*.⁶

Another speed-control option is to use an AC motor with an intermediate drive device that allows adjustable speed ratios. Eddy-current and hydraulic couplings allow varying degrees of slip between the driver and the driven equipment to achieve the desired output speed. In eddy-current couplings, the motor slip and rotational speed are controlled by adjusting the strength of the magnetic field in the coupling. In hydraulic couplings, a pump similar to the one used in automobile transmissions allows fluid to recirculate rather than perform mechanical work. Drawbacks to these devices include relatively low efficiency, compared to that of other speed-control devices, and high maintenance costs. For additional information, refer to AMO’s motor Energy Tips sheets: *Is it Cost-Effective to Replace Old Eddy-Current Drives?*⁷ and *Magnetically Coupled Adjustable Speed Motor Drives*.⁸

Multiple-Speed Motors. Multiple-speed motors are another speed-control option. AC motors can be built to operate at different, discrete speeds using two principal approaches. First, these motors can be constructed with multiple windings, one for each speed. Such motors are usually two-speed, but they can be built to run at three or four speeds. Motors with different sets of windings, (such as cooling tower fan-drive motors) are used in many cooling system applications, so they can operate at different speeds when *ambient* conditions (temperature and/or humidity) change. In general, these motors are less efficient because of the effects of the additional windings. Second, in many multiple-speed motors, a single winding can be controlled with a starter that allows the winding to be reconfigured into different speeds (with a ratio of only 2:1).

A principal advantage of multiple-speed motors is their ability to operate at different speeds using a compact motor/drive assembly. Floor space is often at a premium, and multiple-speed motors are space savers. Alternative speed-control options often take up space, must be inserted between the motor and the driven equipment, and require additional maintenance.

Torque

Torque is the rotational force that a motor applies to its driven equipment and a fundamental factor in motor performance. The torque capacity of a motor depends on many design characteristics. Figure 5 shows a speed-torque curve for a typical induction motor. Starting- or locked-rotor torque is the steady-state torque developed by the motor when it is first energized, and it is the same torque generated during locked rotor and stall conditions. This torque value is important because, even if a motor has sufficient horsepower, it could overheat before reaching operating speed if it cannot accelerate the load from resting state.

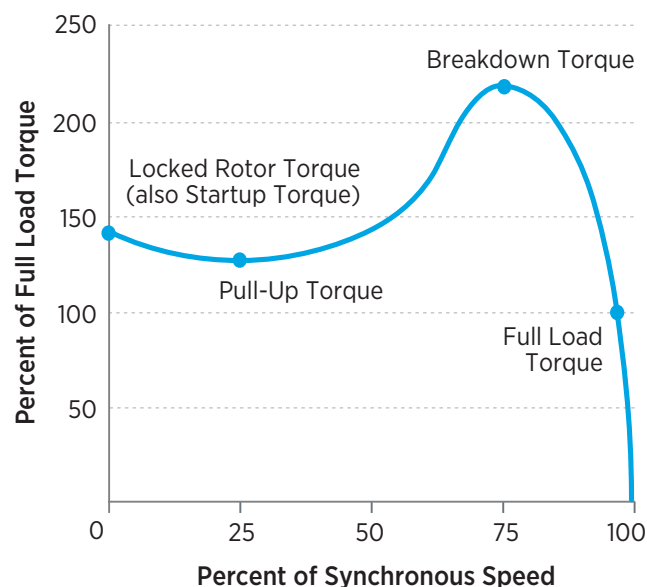

Figure 5. Typical NEMA Design B induction motor speed-torque curve

⁵ www.eere.energy.gov/manufacturing/tech_deployment/pdfs/motor_tipsheet15.pdf

⁶ www1.eere.energy.gov/manufacturing/tech_assistance/motors.html

⁷ www.nrel.gov/docs/fy13osti/56009.pdf

⁸ www.eere.energy.gov/manufacturing/tech_deployment/pdfs/motor_tip_sheet13.pdf

Pull-up torque is the minimum torque that the electric motor develops when it runs from zero to full-load speed (before it reaches the breakdown torque point). Full-load torque is the torque produced by the motor at rated horsepower and speed. Motors sometimes exceed full-load torque during changes in the load; however, sustained operation above full-load torque can reduce the operating life of a motor. Breakdown torque is the maximum torque that the motor can generate without an abrupt drop in speed. If the load exceeds this torque, the motor will stall, causing it to rapidly overheat and risking insulation failure if it is not properly protected.

Load Characteristics

There are four basic types of loads:

- Variable torque
- Constant torque
- Constant horsepower
- Cyclic loads.

The most common type of load has variable torque characteristics, in which horsepower and torque vary with respect to speed. For example, in centrifugal pumps and fans, torque varies according to the square of speed.

In a constant-torque load, the torque is independent of speed. Common applications include conveyor systems, hoists, and cranes. For example, conveying a 500-pound load along an assembly line requires the same amount of torque whether it is moving at a constant speed of 5 feet per minute or 10 feet per minute. Although horsepower varies linearly with respect to speed, torque is constant.

In other types of equipment that require a constant torque—such as centrifugal air compressors, positive displacement pumps, and positive displacement blowers—the relationship between flow and power is linear. This means that energy savings due to reduced flow operation are reduced when compared to variable torque pumps and fans. Some energy-saving measures, such as using ASDs, can also save energy with these other systems. However, significant energy savings occur only in certain applications, such as rotary-screw compressors with variable loads. In addition, many common design and operating practices tend to reduce system efficiencies, particularly with respect to compressed air systems.

In a constant horsepower load, the torque increases with decreasing speed and vice versa. A good example of this type of load is a winding machine in which the torque increases as the roll thickness builds up and the rotational speed slows down. Machine tools such as lathes and cutting machines also display these operating characteristics.

A cyclic load is one in which the torque changes significantly within a cycle or over a series of cycles. An example is an oil well pump; in this application, the downstroke of the pump piston requires much less force than the upstroke. Also, some air compressors and refrigeration system compressors have cyclic load characteristics; they tend to shut down and start up in response to system pressures.

Load inertia refers to the resistance of the load to changes in speed. Applications that have high load inertia tend to require high starting torques. Load inertia is commonly referred to by the term Wk^2 . Examples of loads with high inertia are large fans and machines with flywheels, such as punch presses. The ratio of load inertia to motor torque has a strong effect on the responsiveness of the motor system to changes in the load.

Affinity Laws

$$\text{Flow}_{\text{final}} = \text{Flow}_{\text{initial}} \left(\frac{\text{RPM}_{\text{final}}}{\text{RPM}_{\text{initial}}} \right)$$

$$\text{Pressure}_{\text{final}} = \text{Pressure}_{\text{initial}} \left(\frac{\text{RPM}_{\text{final}}}{\text{RPM}_{\text{initial}}} \right)^2$$

$$\text{Power}_{\text{final}} = \text{Power}_{\text{initial}} \left(\frac{\text{RPM}_{\text{final}}}{\text{RPM}_{\text{initial}}} \right)^3$$

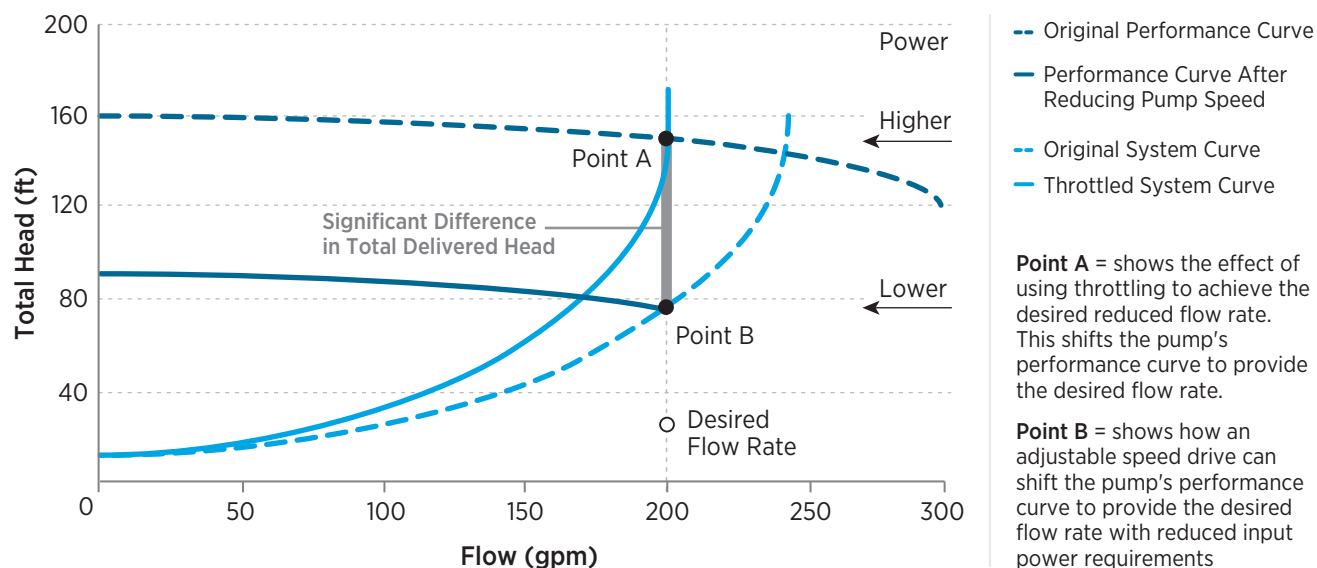

Figure 6. Effect of speed reduction on the power used by a pump

Matching Motors and Drives to Their Applications

To select the proper motor for a particular application, the engineer needs to consider the basic requirements of the service. These include the load profile, environmental conditions, the importance of operating flexibility, and reliability requirements. About 60% of the energy consumed by industrial motor-driven applications is used to drive pumps, fans, and compressors. Within these applications, centrifugal pumps and fans share some common relationships between speed (commonly measured in RPM), flow, pressure, and power; these are known as affinity laws (see sidebar).

One important implication of these laws is that power consumption is highly sensitive to operating speed. Increasing the speed of a fan or a pump requires a relatively large increase in the power required to drive it. For example, doubling the speed of the machine requires eight times more power. Similarly, decreasing the speed of a fan or pump removes a significant load from the motor.

The pump performance curve shown in Figure 6 illustrates the relationship between power and speed. The operating point is the intersection between the system curve and the pump’s performance curve. To achieve the desired operating flow with a fixed-speed pump, a throttle valve is used to control flow. The throttle valve increases the pressure in the pipe and takes pump performance to Point A on the original performance curve. Opening the throttle valve drops the pressure.

The input power to the pump-drive motor is proportional to the product of the flow and head at the operating point. Note how the amount of pressure supplied by the pump is dramatically reduced by slowing its rotational speed. Reducing the pump’s speed with an ASD takes the pump to operating Point B. Although operating Point B provides the same desired flow rate, it does so with reduced pressure and power requirements. At Point B, the pump operates much more efficiently, thus saving energy. There is no longer a large pressure drop across the throttle valve, so maintenance requirements, system noise, and system vibration are reduced. Additional examples of this relationship are shown in figures 7 and 8.

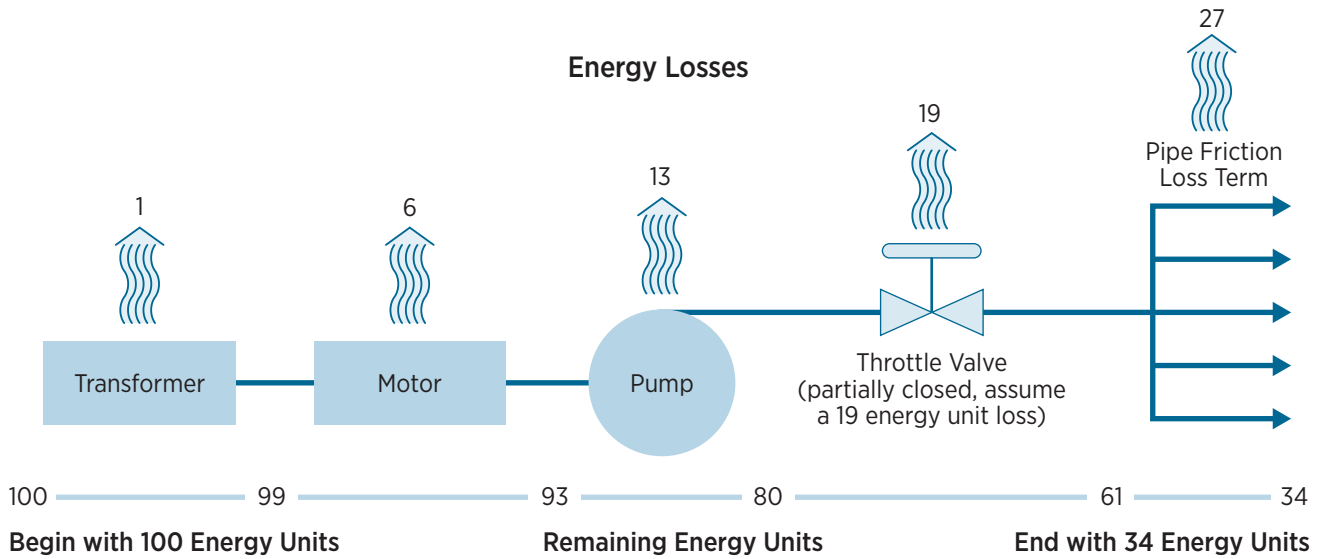

Figure 7. Energy losses in a pump system when a throttle valve controls flow

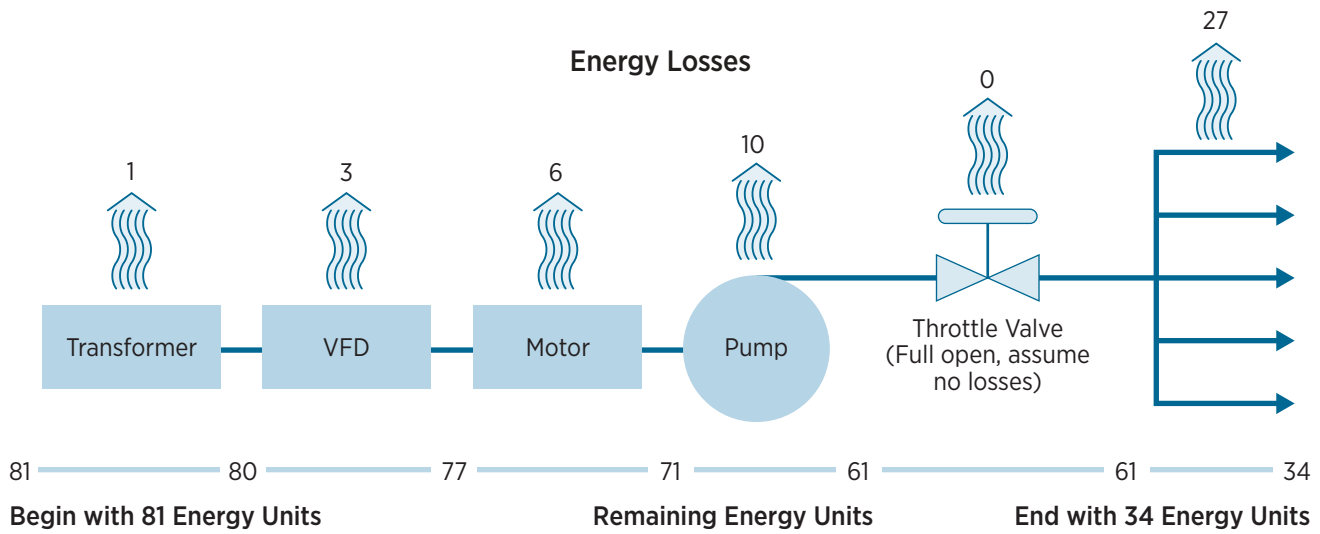

Figure 8. Energy losses in a pump system when an ASD controls flow

Replacing a control valve with an ASD can increase system efficiency and provide significant energy savings. Note that in Figure 7, 100 energy units are supplied to the system; however, in Figure 8, the ASD system does the same work while requiring only 80 energy units. With the ASD, much less energy is lost across the throttle valve because the pump generates less flow.

Pumps

Centrifugal pumps are the type most commonly used, primarily because they are low in cost, simple to operate,

reliable, and easy to maintain. In addition, they have relatively long operating lives.

System designers and engineers need to understand specific system operating conditions to size a centrifugal pump correctly. Many engineers tend to be conservative in estimating system requirements, and they often increase the size of the centrifugal pump and motor to accommodate design uncertainties, potential capacity expansions, and increases in friction losses due to system fouling and changes over time in pipe surface roughness. However, this approach often leads to oversized pump/motor

assemblies. Oversizing can increase throttling and its associated energy losses, resulting in increased operating costs and maintenance requirements, and reduced system reliability because of added stresses on the system.

Pumping systems often operate inefficiently because of poor flow-control practices. Flow-control options include throttle valves, bypass valves, multiple-speed pumps, parallel pump configurations, and pumps coupled to ASDs. Each flow-control method has advantages and drawbacks, depending on the particular application. When they are incorporated properly into a system, these methods provide adequate and efficient flow control. However, improper design or use can increase system costs significantly.

ASDs help to match the flow energy delivered to the system to the system's actual need. In pumping systems, VFDs are by far the most commonly used adjustable speed option. Reducing the pump speed proportionally reduces the flow while exponentially reducing the power requirement. Although installing VFDs can result in substantial energy savings, VFDs are not suitable for all applications, particularly those in which pumps operate against high static (or elevation) head. Static-lift pumping applications are discussed in the "System Efficiency Improvement Opportunities" chapter of AMO's *Continuous Energy Improvement in Motor Driven Systems*.⁹

A useful tool for evaluating potential pumping system improvements is the Pumping System Assessment Tool (PSAT).¹⁰ Developed with the support of the DOE Advanced Manufacturing Office (AMO), formerly the Industrial Technologies Program (ITP), and available at no charge to users, the PSAT software helps the user evaluate pumping systems to determine which pumps offer the best efficiency improvement opportunities. A screening process identifies pump applications that are worth investigating further, and PSAT prompts the user to acquire data for detailed analysis. For more information on PSAT and on properly matching pumps to system requirements, see *Improving Pumping System Performance: A Sourcebook for Industry*.¹¹

⁹ www.eere.energy.gov/manufacturing/tech_assistance/motors.html

¹⁰ www.eere.energy.gov/manufacturing/tech_deployment/software_psat.html

¹¹ www.eere.energy.gov/manufacturing/tech_deployment/pdfs/pump.pdf

Fans

A fan *characteristics* or *performance curve* is a plot of possible pressure and delivered flow operating points (Figure 9). The intersection of the fan performance and system curves defines the actual fan operating point. The operating point indicates the flow rate [cubic feet per minute (cfm)] that the fan will deliver at the indicated static pressure [inches of water gauge (in-wg)]. Based on the way that they impart flow energy to the airstream, fans can be grouped into two fundamental classifications: axial fans and centrifugal fans.

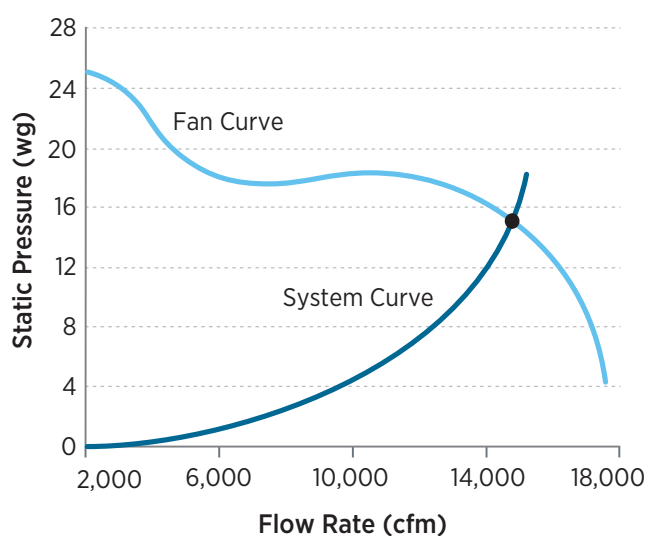

Figure 9. Typical fan and system curves

Axial fans move air along the axis of a fan, much like a propeller. Centrifugal fans use a rotating impeller to accelerate air outward. This acceleration increases the kinetic energy of the airstream, which translates into an increase in pressure. These differences have several implications with respect to motors. Axial fans usually operate at higher speeds and, in some cases, they are directly coupled to the motor. Centrifugal fans tend to be heavier, and they often have high-load inertia. This high-load inertia can affect a plant's electrical distribution system, especially when the fans are started. However, many large fans can be equipped with suitable soft-start devices that avoid the stresses of across-the-line starts.

Most fans are driven by induction motors that operate at 3,600, 1,800, and 1,200 RPM. Because these motor speeds are usually too high for direct drives, belt drives are usually used to establish the desired fan speed. Important

exceptions to this guideline are vaneaxial fans. These fans are compact, efficient, and usually equipped with small fan blades to minimize the stresses caused by high-rotating speeds.

Fan system designers also tend to be conservative, often specifying a larger fan than the system requires. However, oversized fans increase operating costs and can cause problems that are similar to those caused by oversized pumps. Oversized fans are often noisier than they should be, and they also require more maintenance.

Because required airflow rates often change according to temperature, production level, occupancy, or boiler load, fans frequently supply varying flow rates. Although alternative flow control measures, such as dampers and inlet guide vanes can be effective, often the most efficient option is to use a speed-control mechanism, such as a VFD, to adjust the fan's output. VFDs often have inherent soft-start capabilities that can limit starting currents. More information on fan systems can be found in *Improving Fan System Performance: A Sourcebook for Industry*.¹²

A useful tool for evaluating potential fan system improvements is the Fan System Assessment Tool (FSAT).¹³ Developed with the support of ITP (now AMO), FSAT software helps the user evaluate fan systems to determine the best improvement opportunities. A screening process identifies fan applications that are worth investigating further, and then prompts the user to acquire data for additional analysis. More information on FSAT and fan systems can be found in *Improving Fan System Performance: A Sourcebook for Industry*.¹⁴

Air Compressors

Compressed air is important to most industrial facilities. It is used for such applications as driving hand tools, supplying pneumatic control systems, applying paints and coatings, and cleaning and drying parts. There are two principal types of air compressors: positive displacement and dynamic. Positive displacement compressors are more commonly used than dynamic ones.

Electric motors provide power to compressors economically, reliably, and efficiently. Most compressors make

use of standard low-voltage polyphase induction motors; however, in some cases, large medium-voltage motors or motors with a higher service factor are used. In certain cases, the engineer can specify an energy-efficient or premium efficiency motor when a plant is purchasing a compressor or a replacement motor. The incremental cost of a premium efficiency motor is usually recovered in a very short time because of the resulting energy savings.

For most compressed air systems, demand varies widely from hour to hour and day to day. Changes in shifts and production levels, as well as downtime on nights and weekends, can create highly variable load-duty cycles. Accommodating these wide fluctuations in demand is a principal challenge of compressed air system design.

The rotary-screw air compressor is the type most widely found in industrial facilities. Using VFD options to control output is becoming more common; however, most control systems still respond to flow changes by either starting and stopping the air compressor, using a load/unload mechanism, throttling the input, employing a variable displacement device, or using some other means of operating the compressor at part load. A load/unload control strategy uses a valve or some other pressure-relieving device to reduce the load on the compressor drive motor so that it continues to operate but under lightly loaded conditions. A variable-displacement control strategy changes the output of the compressor by controlling the displacement volume.

These output-control options for motor and drive systems can result in frequent starts and shutdowns or motors operating at low loads. Frequently starting and stopping large AC motors can cause power quality problems for the electrical distribution system and can cause motors to run at high temperatures. In addition, part-load operation of a motor usually results in a low-power factor, which, if not corrected, can lead to utility-imposed power factor penalties. For more information on compressed air applications, see *Improving Compressed Air System Performance: A Sourcebook for Industry*.¹⁵

A useful tool for assessing improvement opportunities in compressed-air systems is AIRMaster+.¹⁶ This software tool was developed to help users simulate existing system operation and test potential modifications.

¹² www.eere.energy.gov/manufacturing/tech_deployment/pdfs/fan_sourcebook.pdf

¹³ www.eere.energy.gov/manufacturing/tech_deployment/software_fsat.html

¹⁴ www.eere.energy.gov/manufacturing/tech_deployment/pdfs/fan_sourcebook.pdf

¹⁵ www.eere.energy.gov/manufacturing/tech_deployment/pdfs/compressed_air_sourcebook.pdf

¹⁶ www.eere.energy.gov/manufacturing/tech_deployment/software_airmaster.html

AIRMaster+ provides comprehensive information on assessing compressed air systems, including modeling existing and future system upgrades; and evaluating the savings, interactive effects, and cost-effectiveness of multiple energy efficiency measures. By evaluating different operating schedules, measures that reduce compressed air requirements, and control strategies, AIRMaster+ can help users determine how best to optimize compressed air system performance.

Other Applications

Motors and drives are also used in a wide range of material handling and material processing services. These applications often have unique load characteristics, so they are somewhat difficult to describe in general terms. For example, material processing loads largely depend on the nature of the material being moved, mixed, chopped, or sifted. Also, these applications may be either batch-type or continuous, and operating priorities vary widely in each of those two categories.

Despite all of these differences, using a systems approach in designing, operating, and modifying motor and drive systems tends to reduce operating costs and increase system reliability. This approach stresses the importance of evaluating how different system components interact and how different control or sizing options can keep the components operating efficiently. One place to start is to evaluate the load-duty cycle of system components.

Load-Duty Cycles

The term *load-duty cycle* (LDC) refers to the amount of time that equipment operates at various loads relative to its rated capacity. An example of an LDC is shown in Figure 10. Because motors are often specified according to worst-case operating conditions, applications in which normal operating loads are much smaller than the worst-case load often force the motor to operate at part-load much of the time. The LDCs for such motors would show a significant number of operating hours at reduced-load levels.

This problem is actually relatively common. *The United States Industrial Electric Motor Systems Market Opportunities Assessment*,¹⁷ sponsored by AMO, found that more than 40% of the motors in industrial applications operate at or below 40% of their load rating. The consequences of operating a motor at these load levels include poor power factor and low efficiency.

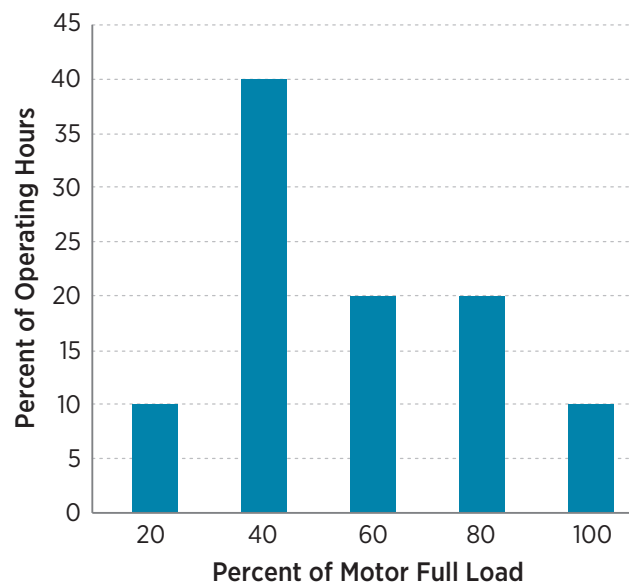

Figure 10. LDC—example 1

When motors operate frequently at low loads and over a wide range of conditions, there are often many excellent opportunities to optimize the entire system, save energy, and improve reliability by making various improvements. Improvement opportunities can include replacing the motor with one of a more appropriate size or type, or installing an adjustable speed drive (or both).

In considering whether to downsize a motor, it is important to check the LDC to avoid overloading the motor during peak-load conditions. This precaution is especially applicable in seasonal industries that experience peak loads only a few times each year. For example, the motor described in Figure 10 operates near full load about 10% of the time. In that case, downsizing the motor could cause overheating, so speed control could be a better solution.

Common Motor Selection Problems

When replacing a standard motor with a premium efficiency one, it is important to pay careful attention to replacement motor performance parameters such as full-load speed and locked-rotor torque. The replacement motor's performance should be as close as possible to that of the original motor. When replacing a motor for driven equipment that uses a VFD as part of the control system, make sure the motor is designed to be used with *inverters*.

¹⁷ www.eere.energy.gov/manufacturing/tech_deployment/pdfs/mtrmkt.pdf

For additional information on premium efficiency motors and motor interactions with VFDs, refer to AMO’s *Premium Efficiency Motor Selection and Application Guide*.¹⁸

Electric motors are relatively inefficient when they are operated at very light loads, that is, below 40% of their rated output. They are usually most efficient when operating between 70% to 80% of rated output. A good rule of thumb is to size motors to operate at about 75% load. This will also provide a safety margin for occasional operational changes that require a higher load; problems such as voltage unbalance that require motor derating; and any errors in the calculation of the motor load.

Oversized Motors

Engineers frequently specify motors that are larger than needed to meet system requirements to ensure that the existing motor/drive assembly can support anticipated increases in capacity. However, the consequences of oversizing motors include the following:

- Lower efficiency
- Higher motor/controller costs
- Higher installation costs
- Lower power factor
- Increased operating costs.

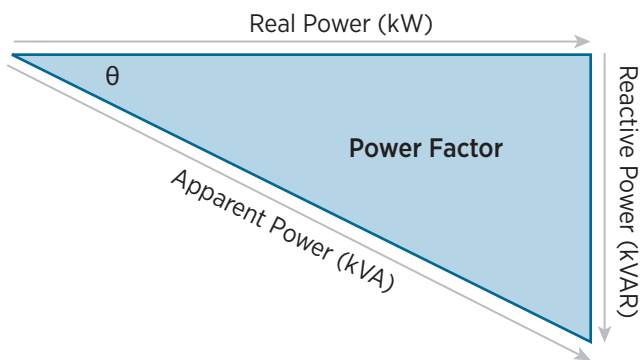

Figure 11. Vector representation of power factor

Poor Power Factor

Another consequence of motor oversizing is low power factor. Lightly loaded motors tend to operate with a low power factor, and many electrical utilities impose a cost penalty based upon plant power factor. Power factor is the ratio of real power (kW)—the power used to perform mechanical work—to apparent power (kVA). In AC induction motors, some of the electrical energy is stored in the magnetic field, creating a time difference between the motor’s peak voltage and its peak current. When current and voltage are out of phase, the amount of real power is less than the amount of apparent electric power available [the scalar product of volts and current (*amps*)] in the in-plant electrical distribution system line. The vector difference between real power and the product of volts and amps is known as reactive power. This relationship is shown in Figure 11.

Reactive power creates additional I²R losses in the distribution system and creates additional stress on transformers. (In I²R, “I” refers to current and “R” refers to resistance. Power lost due to current flow is thus the product of the resistance and the square of the current.) Consequently, utilities often assess fees for reactive power to recover the costs associated with losses on their distribution equipment. Plants that have large motor systems often face substantial power factor penalties; therefore, many facilities invest in capacitors to increase their overall power factor and thus minimize these costs. For additional information, refer to the “Power Factor Correction” chapter of AMO’s *Continuous Energy Improvement in Motor Driven Systems*.¹⁹

Undersized Motors

Another type of motor selection problem is undersizing the motor for the intended application. Motors should be sized to deliver from 75% to 100% of their rated horsepower. The principal consequence of operating a motor above its rated horsepower output is a higher winding temperature, which shortens the life of the motor winding insulation. If the motor has a service factor of only 1.0, the motor lifetime may be as short as a few months if the motor is operated above rated load or operated at rated load when power quality problems are present.

¹⁸ www1.eere.energy.gov/manufacturing/tech_assistance/motors.html

¹⁹ www1.eere.energy.gov/manufacturing/tech_assistance/motors.html

As a rule of thumb, every 10°C rise in winding temperature reduces insulation life by half. Although motor efficiency drops off slightly at higher-than-rated loads, the increase in energy cost is usually not as severe as the cost associated with shorter intervals between repairs or replacements.

Motor Full-Load Speed

For centrifugal loads such as those imposed by fans or pumps, even a minor change in a motor's full-load speed translates into a significant change in load and annual energy consumption. Fan or "affinity" laws indicate that the horsepower loading imposed on a motor by centrifugal equipment varies as the third power or cube of its rotational speed. In contrast, the quantity of air or flow of water delivered varies linearly with speed.

Premium efficiency motors tend to operate with reduced "slip" or at a slightly higher speed than their standard-efficiency counterparts. This small difference— an average of only 5 to 10 RPM for 1,800-RPM, synchronous-speed motors—is significant. A seemingly minor 10-RPM increase in a motor's full-load rotational speed from 1,760 to 1,770 RPM can cause up to a 1.6% percent increase in the load placed upon the motor by the rotating equipment. A 20-RPM speed increase can boost both load and energy consumption by 3.3% percent, completely offsetting the energy and dollar savings expected from the purchase of a premium efficiency motor. For additional information on this topic, see the "Efficiency Gains and Motor Operating Speed" section of the AMO's *Premium Efficiency Motor Selection and Application Guide*.²⁰

Summary

Motor and drive systems can be highly efficient and reliable if they are specified, configured, and maintained properly. However, significant performance improvement opportunities can often be found in systems with poorly sized, ill-configured, or inadequately maintained motors. Often, most of the energy used by the motor systems in an industrial facility are concentrated in a few processes. These systems tend to feature large motors that run much of the time.

Energy-intensive motor and drive systems tend to be critically important to production. So, they might not often be considered for efficiency improvements because they would have to be taken out of service for modifications or replacement. However, because of the close relationship between motor efficiency, performance, reliability, process uptime, and productivity, it can be beneficial to implement energy efficiency measures that provide secondary benefits.

Often, the most important benefit of an energy efficiency project is an increased level of motor reliability (i.e., extended mean time between failures or uninterrupted service). Consequently, engineers, managers, and operators can give their plants an important competitive advantage by using a systems approach—one that includes all the benefits of greater system efficiency—to assess their motor and drive applications.

²⁰ www1.eere.energy.gov/manufacturing/tech_assistance/motors.html

SECTION 2: PERFORMANCE OPPORTUNITY ROAD MAP

Overview

For cost-effective operation and maintenance of a motor and drive system, operators must pay attention to the entire system as well as to its individual components. Often, when investigating efficiency opportunities, operators are so focused on the immediate demands of this equipment that they overlook the bigger picture, which includes the ways in which system parameters affect all the equipment.

This big-picture view is embodied in the *systems approach*. In this approach, the engineer analyzes the system itself and how its components interact, essentially shifting the focus from individual components to total system performance.

A systems approach usually involves the following types of interrelated actions:

- Establishing current conditions and operating parameters
- Determining present process production needs and estimating future ones
- Gathering and analyzing operating data, and developing load-duty cycles
- Assessing alternative system designs and improvements
- Determining the most technically and economically sound options, taking all subsystems into consideration
- Implementing the best option
- Assessing energy consumption with respect to performance
- Continuing to monitor and optimize the system
- Continuing to operate and maintain the system for peak performance.

Efficiency Opportunities

The rest of this section describes seven efficiency opportunities that address both component and system issues. Each one details a specific opportunity for improving motor system performance:

1. Assessing Motor and Drive System Operating Conditions
2. Establishing a Motor Management Program
3. Providing Basic Maintenance
4. Selecting the Right Motor
5. Using Adjustable Speed Drives
6. Addressing In-Plant Electrical Distribution and Power Quality Issues
7. Using the Service Center Evaluation Guide.

Efficiency Opportunity No. 1: Assessing Motor and Drive System Operating Conditions

Effective motor and drive system management can reduce operating costs, improve performance, and increase reliability. An important first step is to determine current operating conditions. In this task, operators evaluate how effectively and efficiently the motors and the driven equipment are meeting the needs of the system. This evaluation has several benefits, which include helping to prioritize performance improvement opportunities and providing a useful baseline for determining whether system efficiency is declining and remedial actions need to be taken.

A large industrial facility can contain thousands of motors, so it is usually not practical to evaluate every motor system in a plant individually. In many facilities, however, most of the energy used by motors is consumed by just a few systems, and these systems are often essential to production. In addition, energy projects involving essential motor systems typically provide the shortest paybacks. Therefore, plant engineers and managers can usually determine the most cost-effective motor improvement projects by first screening all their motors to identify those that are essential and that consume the most energy. For additional information on motor screening and survey techniques, see the “Conducting a Motor Survey” chapter in *Continuous Energy Improvement in Motor Driven Systems*.²¹

²¹ www1.eere.energy.gov/manufacturing/tech_assistance/motors.html

The following sequence of steps can help plants identify the best opportunities for motor system improvements.

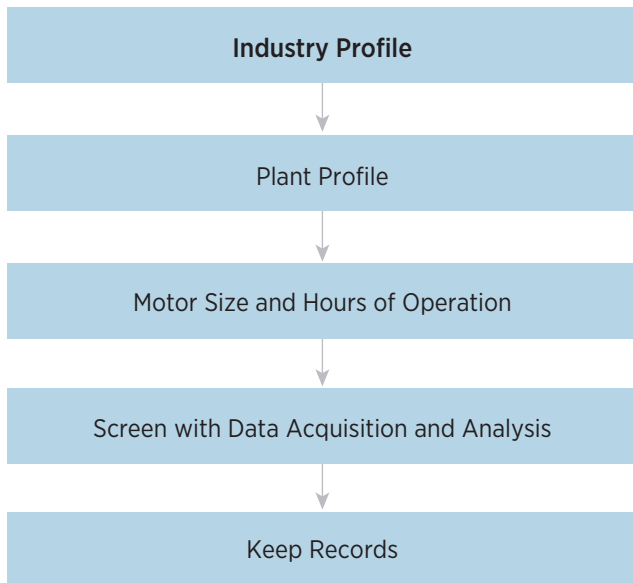

Industry Profile

Different industries have different motor system requirements. But in general, the largest motor system energy consumers can be found in industries that make frequent use of pumps, fans, material handling systems, and air compressors. The *United States Industrial Electric Motor Systems Market Opportunities Assessment*, a helpful resource developed by the U.S. Department of Energy (DOE) Advanced Manufacturing Office (AMO), formerly the Industrial Technologies Program (ITP), provides motor use profiles for many manufacturing industries.²² This publication can help users identify the systems in their plants that use the most energy.

The AMO’s “Manufacturing Energy and Carbon Footprints” documents map the flow of energy from supply to end use in U.S. manufacturing industries. These publications identify the sources and end uses of energy to help pinpoint areas of energy intensity and characterize the unique energy needs of individual industries.²³

²² www.eere.energy.gov/manufacturing/tech_deployment/pdfs/mtrmkt.pdf
²³ www.eere.energy.gov/manufacturing/resources/footprints.html

Plant Profile

Even within a particular industry, motor requirements can vary widely and depend on each plant’s level of integration. Consequently, staff in each facility should review plant processes to identify the most energy-intensive motor systems. A walk-through inspection of the larger motor systems, paying particular attention to how their operation and/or flow in the system is controlled, can help staff get started. The MotorMaster+ software tool, which was developed by AMO, can be helpful in creating a profile, and documenting and analyzing plant’s motor use.²⁴

Motor Size and Hours of Operation

Screening a plant’s motors by motor size and annual operating hours can make it easier to identify the best opportunities for improvements. Large motors that operate for long periods of time are usually the best candidates for improvements. From a cost-effectiveness standpoint, it can be difficult to justify making efficiency and performance improvements to small motors or motors that run infrequently. Additional information on motor screening is available in the “Conducting a Motor Survey” chapter of AMO’s *Continuous Energy Improvement in Motor Driven Systems*.²⁵

Data Acquisition and Analysis

After identifying the most energy-intensive motor systems, the user can start collecting operating data on the motors and the systems slated for improvements. The data can be acquired by measuring the electrical power supplied to the motor and, in some fluid systems, by measuring the fluid power generated by a pump or fan.

When pressure and flow rate data are available, motor loads can often be estimated by measuring the pressure developed by the fan or pump. If performance curves for the fan or pump are available, then the motor load corresponding to these pressure data can be determined.

Material handling, compressed air, and some other systems do not usually have the instrumentation needed to estimate motor loads. In these cases, loads must be measured electrically. This can be done in any of several ways, depending on how the motor and the motor controller are

²⁴ www.eere.energy.gov/manufacturing/tech_deployment/software_motormaster.html
²⁵ www1.eere.energy.gov/manufacturing/tech_assistance/motors.html

configured. In many applications, an electrician can access the motor control center and connect a power meter to directly measure input kilowatts, voltage, current, and power factor. Often, these measurements can be helpful in evaluating other aspects of motor systems, including tuning the in-plant distribution system. For additional information on this topic, refer to the “Motor Load and Efficiency Estimation Techniques” chapter of *Continuous Energy Improvement in Motor Driven Systems*.²⁶

For more information on some of the electrical problems that impair the performance of motor systems, see “Efficiency Opportunity No. 6: Addressing In-Plant Electrical Distribution and Power Quality Issues” later in this section. Electrical measurements are also useful in determining system economics, as discussed in Section 3 of this sourcebook on motor and drive system economics.

A load-duty cycle (LDC) is helpful and often necessary for evaluating motor system improvement opportunities. In many systems, loads vary significantly, depending on the weather, production demand, seasons, and product mix. Similarly, some motors normally operate near their full-load rating, while others normally operate at small portions of their full-load rating. LDCs, developed from power-logging data, indicate the percentage of time that a motor operates at a given load, as shown in Figure 12. LDCs should be developed for large motor systems serving variable loads. Depending on the factors that drive the system load, it may be feasible to develop separate LDCs for different seasons and product types.

System energy demand is an important data component that should be acquired, if possible. Correlating the system demand to a motor’s power use provides a helpful indication of motor system efficiency. Examples of system demand are fluid power (especially in pumping and fan systems) and the combination of torque and speed (in material handling systems).

For more information on how different LDCs can impact motor selection, see “Efficiency Opportunity No. 4: Selecting the Right Motor” later in this section.

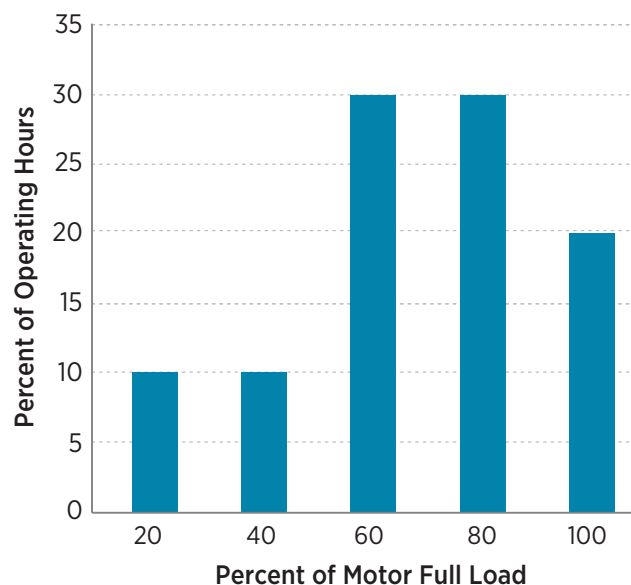

Figure 12. LDC—example 2

Record Keeping

Creating an inventory record of energy-intensive [for example, more than 50-horsepower (hp)] or production-critical motors can be valuable in developing maintenance schedules and in tracking motor life and performance. Maintaining a history of motors and their load-duty cycles facilitates the evaluation of energy efficiency improvement opportunities and monitoring of performance trends. These records can also be used to determine whether maintenance schedule adjustments are required. The MotorMaster+ software is a useful tool for developing and maintaining these records.

For more information on motor management, see “Efficiency Opportunity No. 2: Establishing a Motor Management Program” or the 1-2-3 Approach to Motor Management tool²⁷ offered by the Motor Decisions Mattersm national awareness campaign.²⁸ Also review the “Motor Efficiency Improvement Planning” chapter of AMO’s *Continuous Energy Improvement in Motor Driven Systems*,²⁹ and the “Premium Efficiency Motor Application Considerations” chapter in the *Premium Efficiency Motor Selection and Application Guide*.³⁰

²⁶ www1.eere.energy.gov/manufacturing/tech_assistance/motors.html

²⁷ www.motorsmatter.org/tools/123approach.html

²⁸ www.motorsmatter.org

²⁹ www1.eere.energy.gov/manufacturing/tech_assistance/motors.html

³⁰ www1.eere.energy.gov/manufacturing/tech_assistance/motors.html

Summary

Determining motor system operating conditions is a good place to start to identify opportunities that reduce motor-related costs, improve performance, and increase reliability. Although motor systems account for a large portion of the energy used at many industrial facilities, motor system management is often reactive, in that improvements are made only in response to obvious problems or motor failures. Adopting a proactive, systems-based approach is a good first step toward realizing the many benefits of an effective motor management program.

Efficiency Opportunity No. 2: Establishing a Motor Management Program

Although most industrial facilities rely heavily on motor systems to maintain or support production, these systems are often overlooked as manageable assets. A formal motor management program expands on the assessment activities (described previously in this section in “Efficiency Opportunity No. 1: Assessing Motor and Drive System Operating Conditions”) by defining strategies that support proactive, cost-effective planning. These strategies include instituting repair/replace and purchasing policies, establishing a motor inventory, tracking motor life, creating a spares inventory, and establishing a schedule for required maintenance. One or more of these strategies can be used, as appropriate, in a motor management program.

The benefits of implementing a motor management program include greater motor reliability, improved overall system performance, and lower energy costs. Additional information on establishing a motor management plan is included in *Continuous Energy Improvement in Motor Driven Systems*.³¹

Instituting a Repair/Replace Policy

When a motor fails, getting it back in service is often a priority, especially if the motor is essential or critical to a production process. However, although a formal repair/replace policy can reduce inconsistencies in motor replace/repair decisions, many facilities do not have one.

An industrial user has two options when dealing with an electric motor failure: (1) replace the existing motor with a new motor, or (2) repair the motor at a qualified service center. Several factors need to be taken into consideration when deciding between these two options. One factor is whether a motor is meeting the plant’s current needs. For example, in production facilities, systems often change as a result of capacity expansions, product redesigns, advances in technology, and so on. Consequently, motor requirements also change. Thus, in some cases, a motor failure can be an opportunity to purchase a replacement motor of a more appropriate type or size. It is wise to conduct a root-cause failure analysis for failed motors, correct system issues, and consider enclosure upgrades. Chronic motor failures can occur because of misuse, misapplication, unsuitability for the operating environment, misalignment/vibration, or poor maintenance practices.

General guidelines on motor replacement and repair options can be found in several resources. For example, *Horsepower Bulletin*, developed by the Industrial Electrotechnology Laboratory (now Advanced Energy) with support from AMO, is a motor management policy guide covering general motor repair and specific information for the National Electrical Manufacturers Association’s (NEMA’s) Designs A and B motors up to 200 hp.³² Another useful resource is an Electrical Apparatus Service Association (EASA) booklet, *A Guide to AC Motor Repair and Replacement*. The Motor Decisions Matter campaign is also a good resource.³³

When the initial costs of motor repair versus replacement are compared, the repair option is usually the least expensive one for larger motors. For additional information, refer to the “Motor Failure and Repair/Replace Decision-Making” section of AMO’s *Premium Efficiency Motor Selection and Application Guide*.³⁴

³² www.advancedenergy.org/md/knowledge_library/resources/Horsepower%20Bulletin.pdf

³³ www.motorsmatter.org

³⁴ www1.eere.energy.gov/manufacturing/tech_assistance/motors.html

³¹ www1.eere.energy.gov/manufacturing/tech_assistance/motors.html

For small general purpose motors, 15 hp and below, it may actually be less expensive to purchase a new premium efficiency replacement motor. Instead of making a repair/replace decision based solely on the initial cost, users can examine both options more thoroughly by means of a life cycle cost analysis. *MotorMaster+ software* from AMO can help conduct this analysis. This analysis takes into consideration two important factors—hours of operation and electricity costs—as well as purchase and repair costs. For example, suppose a hypothetical 100-hp, 94.5% efficient motor operates 6,300 hours per year for 18 years at a cost of \$0.075 per kilowatt-hour (kWh). In this case, electricity costs represent approximately 95% of the motor’s lifetime operating costs. Initial motor purchase price and repair costs account for only 5% of the total costs over the motor’s operating life.

Instituting a Purchasing Policy

A motor purchasing policy accomplishes several key objectives:

- Ensures consistency in procurement
- Helps to ensure that the most appropriate, cost-effective motor is chosen for each application
- Streamlines the approval process for purchasing premium efficiency motors, when appropriate
- Demonstrates management support for decisions based on life cycle costs.

To be effective, the policy must be supported by management and disseminated to all those who regularly make motor-related decisions. Several sample policies are available. NEMA’s General Specification for Consultants, Industrial and Municipal: NEMA Premium Efficiency Electric Motors (600 Volts or Less) covers many design criteria as well as material and mechanical considerations.³⁵

Obtaining a Quality Motor Repair

The cost benefits of repairing an existing motor usually can be realized only if the repair results in a slight deviation, or none at all, from the motor’s original specifications

and performance. Assurance of this result can be obtained by researching prospective motor service centers. Evaluating repair facilities (service centers) provides quality control advantages similar to those gained when facilities evaluate vendors and suppliers of their parts and materials. However, evaluating a facility *after* a motor failure can result in a costly loss of production time. The recommended practice is to evaluate repair facilities in advance. This can benefit both the motor user and the motor service center. The motor user can ensure the quality of the motor repairs and the motor service center can benefit from knowing what its customers expect.

The AMO-sponsored publication *Model Repair Specifications for Low-Voltage Induction Motors* was developed by Washington State University to provide detailed repair specifications.³⁶ Several other resources also discuss motor repair specifications. See, for example, ANSI/EASA Standard AR100-2010 *Recommended Practice for the Repair of Rotating Electrical Apparatus and Electric Motor Repair Specifications*.³⁷

Along with analyzing cost issues to support a motor replacement/repair decision, motor repair quality is an important consideration. The *Service Center Evaluation Guide* provides useful information on service center quality,³⁸ see “Efficiency Opportunity No. 7: Using the Service Center Evaluation Guide.” This guide discusses the attributes that a motor user should look for in a motor repair service center, and it provides a checklist to help the user perform the evaluation.

Another source of information regarding motor repair quality is EASA-Q.³⁸ EASA standards contain guidelines for motor repair service shops, and the recommended practice discusses in some detail the minimum practices that motor service shops should follow. EASA-Q is a service shop evaluation program that parallels the International Organization of Standardization (ISO) 9000 standards for best management practices with respect to motor repair quality assurance.

³⁵ www.nema.org/Standards/Pages/General-Specification-for-Consultants-Industrial-and-Municipal-NEMAPremium-Efficiency-Electric-Motors.aspx

³⁶ www.eere.energy.gov/manufacturing/tech_deployment/pdfs/repair_specs_motors.pdf

³⁷ www.easa.com/sites/default/files/AR100-2010_1010-2.pdf

³⁸ <https://secure.easa.com/resources/cgis/displayitem.cgi?category=8&name=Quality+Assurance&item=1>

Using MotorMaster+ for Motor System Management

AMO helped to develop the MotorMaster+ software tool, designed to assist industry in identifying and analyzing motor efficiency opportunities and to better manage electric motor systems.³⁹ MotorMaster+ can access list price and performance data from nearly 17,000 industrial electric motors and perform several tasks to help motor users with system management. These tasks include performing a comparative benefits analysis for replacing existing in-service motors with possible alternatives, maintaining a plant's electric motor inventory, keeping a historical record of motor maintenance actions, and calculating the life cycle costs for potential motor efficiency improvement projects.

MotorMaster+ helps users to find the most energy-efficient motors that meet the requirements of the application and to compare the life cycle costs of potential replacements with the cost of a typical repair.

The electric motor database includes all NEMA and some International Electrotechnical Commission (IEC) metric motor models from 1 to 4,000 hp that operate at speeds of 900, 1,200, 1,800, and 3,600 RPM at ratings up to 6,600 volts (V). To ensure consistency among various manufacturers, electric motor efficiency data are taken in accordance with industry standards for measuring full- and part-load efficiencies.

MotorMaster+ was developed to achieve four basic objectives:

- Increase awareness of electric motor system efficiency opportunities
- Emphasize a life cycle cost approach to analyzing savings from motor replacement decisions
- Assist motor users in selecting the proper motor for an application
- Assist users in establishing an effective motor system management program.

Increase Awareness of Motor Efficiency. Purchasing electric motors is a common and recurring procurement activity in most large industrial plants. The need to replace one or several motors is also an opportunity to improve the efficiency of a plant's motor systems. MotorMaster+ can help motor users understand how motor efficiency affects the life cycle cost of an electric motor.

Using MotorMaster+, users can create a list of motors that includes performance and cost specifications to match specific operating requirements. This allows the user to view all possible motors, sorted by motor efficiency, for an application. MotorMaster+ can also compare an existing motor economically with other motors available in the market, as well as compare the cost of a new motor with that of a repaired motor to find the most cost-effective option.

Two methods can be used to perform a comparative analysis. The first method is a simple payback analysis to compare two motors at a time. MotorMaster+ calculates annual energy and demand costs, and determines the simple payback period. If the user wants to perform a more in-depth analysis, MotorMaster+ will perform a life cycle analysis on all motor and repair options.

Track Motor Lifetimes and Life Cycle Costs. Although many economic decisions are based on initial capital costs, hurdle rates, and/or payback periods, a life cycle analysis presents a more realistic view of the investment value. The life cycle module in MotorMaster+ enables users to evaluate comprehensive costs and benefits, considering capital depreciation, associated costs, financing details, electricity use, and the expected lifetime of the project. The program calculates life cycle costs using various user-established scenarios

For example, the life cycle module depreciates capital equipment using several methods to incorporate these benefits into the final analysis. End-users can choose between the straight-line, sum-of-year-digits, and double-declining balance methods to account for depreciating assets.

Like a typical life cycle analysis, MotorMaster+ accounts for associated costs and financing details such as capital, installation, operation and maintenance, and fuel costs, along with different interest and tax rates. In addition, MotorMaster+ allows the user to input different fuel and electrical energy cost escalation scenarios for the predicted lifetime of the project.

³⁹ www.eere.energy.gov/manufacturing/tech_deployment/software_motormaster.html

MotorMaster+ also allows the user to input details about the plant's electricity service. Users have the flexibility to define the operating conditions related to electrical power to reflect realistic rate schedules, including electricity and demand charges, and specific load profiles.

All of these parameters are integrated into the life cycle cost analysis according to the lifetimes of the proposed projects, along with the equipment life expectancy, the depreciation life, the salvage value, and the scrap value. MotorMaster+ life cycle cost outputs include the rate-of-return on investment, levelized cost of energy savings, net present value, and the benefit-to-cost ratio.

MotorMaster International

Some users might want to use the MotorMaster International software⁴⁰ rather than MotorMaster+. The international version includes many of the capabilities and features of MotorMaster+, but it also allows users to evaluate repair/ replacement options on a broader range of motors. The user can conduct analyses in different currencies, display results in the numerical format selected on the host computer's "Regional Settings," calculate efficiency benefits for utility rate schedules with kilowatt (kW) and kilovolt-ampere (kVA)-based demand charges, and determine "best available" potential replacement motors. This tool has been converted to operate in English, Spanish, French, German, Traditional Chinese, and Simplified Chinese.

Improve Motor Selection Methods. Although low life cycle costs are an important factor in selecting a motor replacement option, several other factors should be considered before making a final choice. These factors include frequent cycling or starting, required start-up torques, insulation class, full-load speed, use of variable-speed drives, a motors-service factor, and enclosure type. In some cases, neglecting these factors may diminish a motor's reliability, negating the benefits of low life cycle costs.

Establishing a Spares Inventory

Once replacement requirements are understood, maintaining a spares inventory will guarantee that a proper replacement motor is available when needed. This inventory helps to ensure that decisions are based on evaluation

and planning rather than availability and first cost. It may also help to minimize downtime associated with unexpected motor failure. Motor sales and service providers are stepping up efforts to work with customers in this area. Customized programs might include stocking, storage, maintenance, and/or tracking agreements. Planning for a "premium efficiency-ready" spare inventory is introduced in AMO's *Continuous Energy Improvements in Motor Driven Systems*.⁴¹

Efficiency Opportunity No. 3: Providing Basic Maintenance

Proper maintenance of motor and drive systems provides several economic benefits. The most obvious benefit is the extended operating life of the equipment. Other benefits include increased reliability, lower life cycle costs, and better use of assets.

As defined in NEMA MG 1-2011 Motors and Generators,⁴² motors are designed to operate under usual service conditions including:

- Exposure to an ambient temperature between 0°C and 40°C
- Installation in areas or enclosures that do not seriously interfere with the ventilation of the machine
- Operation within a tolerance of $\pm 10\%$ of rated voltage
- Altitude not above 3,300 feet.
- Operation within a tolerance of $\pm 5\%$ of rated frequency
- Operation with a voltage unbalance of 1% or less
- Full voltage across-the-line starting.

Motor systems are essential to industrial facility operations, so a motor failure can cause costly production delays. By minimizing the risk of unplanned downtime, effective maintenance programs can help plants avoid costly disruptions in production.

⁴⁰ www.eere.energy.gov/manufacturing/tech_deployment/software_motormaster_intl.html

⁴¹ www1.eere.energy.gov/manufacturing/tech_assistance/motors.html

⁴² www.nema.org/Standards/ComplimentaryDocuments/Contents%20and%20Forward%20MG%201.pdf

Preventative Maintenance

Inspections. Inspections of motor and drive system components should be based on such factors as run time, environmental conditions, consequences of failure, and so on. Often, these inspections can and should be combined with cleaning to remove contaminants from the motor.

Moisture or contaminated lubricant on motor windings, or both, accelerates motor wear by reducing the life of the insulation. Moisture directly reduces the dielectric strength of insulation, increasing the risk of sudden failure. Lubricant that is contaminated by particulates can also have reduced dielectric strength while encouraging the accumulation of contaminants. Because windings shift around in reaction to thermal and magnetic forces, contaminants on the winding insulation create abrasive wear that can lead to early insulation failure.

Because of potential problems with the brush assemblies, DC motors tend to require more frequent inspection and maintenance. Brush problems include poor contact, misalignment, and sparking. These problems can lead to quick deterioration of the brushes and damage to the slip ring or commutator surface on the motor shaft, an even greater consequence. Although the brushes themselves are relatively inexpensive, if the slip ring or commutator surface becomes pitted or out-of-round because the brushes are operating poorly, repairs can be costly and time intensive.

The causes of these problems include poor installation, poor maintenance practices, and maintenance practices that can introduce contaminants. Contamination is particularly problematic in brush assemblies in which silicone-based insulation is used. The off-gassing that occurs from the insulation as it is heated during operation can cause the brushes to deteriorate quickly. Therefore, relatively frequent brush problems should be investigated to see whether the cause is exposure to silicone materials.

Table 1 contains a list of basic inspection and maintenance tasks and the recommended intervals for performing them.

Insulation Resistance Checks. Measuring the motor winding insulation resistance can indicate cleanliness and moisture levels and help to determine the potential for insulation failure. This test is performed by applying a voltage (typically 500 or 1,000 V) to the motor windings and measuring the resistance from the insulation to ground. Expected resistances should be on the

order of megohms as outlined in the Institute of Electrical and Electronics Engineers (IEEE) Standard 43-2000 *Recommended Practice for Testing Insulation Resistance of Rotating Machinery*.⁴³

A megohmmeter is used to measure the insulating resistance of electrical materials. Megohmmeter checks are commonly done on in-service motors, motors that have been idle for some period, and motors that might be wet. Wet insulation is a common cause of low insulation resistance. Energizing motors with weak or wet insulation can lead to catastrophic failure of the motor. Therefore, a low insulation resistance reading should be investigated further. Then, the insulation resistance should be remeasured to see if moisture was the problem or if the insulation itself is weak.

The insulation should be checked before more extreme measurement methods are used, such as a “hi-pot” (high-potential) test. Because hi-pot tests expose the insulation to much higher voltages, an insulation resistance check can indicate whether such a measurement will cause insulation damage. When the insulation has been exposed to moisture, an insulation resistance check can indicate the need to dry the equipment before conducting additional tests.

A hi-pot test measures the dielectric strength of winding insulation and can determine whether the insulation has a weakness that may cause failure when the motor is operating. A high-pot test typically applies more than 1000 V to the windings for new motors, with 60% of this voltage applied to used motors. Generally, this test is used on new motors, but it may be recommended for motors that have been idle for long periods. Because the test itself can damage the insulation, the manufacturer’s guidelines should be carefully followed.

Balance and Alignment Checks. Like most rotating machinery, motors can be seriously affected by dynamic unbalances. The causes of balance problems include overhung loads; poor alignment between the motor and the driven equipment shafts; shaft deflection; an imbalance in the driven equipment that transfers vibrations to the motor; and a weight imbalance on the motor fan or the motor shaft. Large, overhung loads create significant radial-load conditions on motor bearings. It is important to design the motor/driven-load assembly properly in overhung load applications to prevent the development of balance and alignment problems.

⁴³ <http://ieeexplore.ieee.org/xpl/articleDetails.jsp?reload=true&arnumber=836297>

PERFORMANCE OPPORTUNITY ROAD MAP

Table 1. Common Inspection Tasks

Interval	Action	Remarks
Weekly	Inspect commutator and brushes	Look for sparking, seating contact, evidence of contamination*
	Check oil level in bearings	Follow manufacturer's recommendations
	Check oil rings	
	Inspect the shaft for signs of oil leakage	
	Inspect starter, switches, and fuses	
	Check the start-up time for the motor	
Every 6 months	Clean the motor thoroughly	Blow out dirt (25–30 psig air); wipe down commutator and brushes
	Check brushes	Inspect for wear; verify proper position and pressure
	Inspect brush holders	
	Check oil quality in sleeve bearings	
	Check grease in antifriction bearings	Follow manufacturer's recommendations
	Check operating speed	
	Verify end-play	
	Check electrical connections	
	Check enclosure	
	Check foundation connections	Look for signs of grout degradation or loosening of shims
	Check insulation resistance	
Annually	Regrease antifriction bearing	Follow manufacturer's recommendations
	Check air gap	
	Check bearing clearances	
	Clean undercut slots in the commutator	

* Never use silicone-based insulation or leads in a motor with brushes.

Alignment problems can result from a poor installation, foundation movement, or bearing system wear. For example, many initial alignment problems can be attributed to the installation sequence. A motor might be correctly aligned to a pump before the system piping is connected to the pump flange. However, when the piping does not line up exactly with the pump flanges, mechanics often “force-fit” the connection during installation. The pull exerted by severe force-fits can cause severe misalignment with the motor/pump shaft system. Similarly, welding tends to distort foundations. Unless the welding process is sequenced to limit this distortion, any machinery alignments should be checked after all the welding is completed.

Shaft deflection is an operating problem usually associated with pumps. It can influence the performance of the motor as a result of the added bearing loads. In pumps, severe shaft deflection usually occurs when the pump operates below its minimum flow requirement.

In addition, rotating imbalances can be caused by the driven equipment. For example, a ventilation fan that operates in a corrosive environment can become unbalanced as the materials in the fan blade degrade or material deposits form on the fan blades. In some applications, the fan-drive motor itself can degrade, causing a damaging imbalance condition.

Motor/foundation interfaces that develop soft-foot problems can also have balance and alignment problems. *Soft foot* refers to the gaps that develop between a motor’s mounting foot and the foundation. It is often the result of material loss around the mounting hardware that allows movement of the motor or drive assembly under load. As the motor or drive “flexes” on its soft foot, the resulting misalignment can produce bearing problems. To avoid this predicament, the condition of the mounting feet should be periodically inspected. If the grout is damaged or if the shims or mounting bolts have come loose, the problem should be corrected and the motor/drive alignment rechecked.

Predictive Maintenance

Predictive maintenance or condition assessment programs are designed to increase the reliability of motor and drive systems. These methods are intended to identify problems that are developing but have not yet created a failure. Some of these techniques may be analyzed in a cost effective manner with industrial wireless sensor networks.

Early identification of a developing problem improves the engineer’s ability to intervene and plan a repair before the motor or drive fails. The most effective predictive maintenance tools for motors include vibration analysis, lubricant analysis, insulation resistance measurement trending (see also the section on insulation resistance in this efficiency opportunity), infrared (IR) scanning, and motor analyzers that can perform motor diagnostic tests.

Vibration Analysis. Commercial vibration analyzers read and evaluate the vibration signature of a motor or other rotating machinery. Recording the vibration characteristics at regular intervals in a motor’s operating life can reveal trends that indicate developing problems. These devices are particularly useful for determining emerging bearing problems. Vibration analyzers can also detect unbalances and misalignments in the shaft system that are caused by loose couplings, motor fan problems, etc. Vibration analyzers are also useful in evaluating the condition of rotor bars in squirrel-cage induction motors. Rotor bars that become loose will display vibration characteristics of a certain frequency.

Lubricant Analysis. A lubricant analysis can indicate the existence or the development of a bearing problem as well as determine whether the lubricant should be replaced. Lubricant analysis can also indicate the presence of high-temperature bearing problems. Lubricants are usually changed permanently by heat. This property is useful in detecting problems, especially intermittent ones. For example, a bearing problem that develops under specific but infrequent operating conditions may not be detected by conventional methods unless that load condition happens to occur during the measurement.

IR Scanning. IR scanning (thermography) is an effective method of determining the condition of insulation and the integrity of a connection. IR scanning evaluates the thermal image of a body to determine its temperature characteristics. Bearings that begin to run hot or loose cable terminations and bus bar connections create additional electrical resistance and will show up as hot spots on an IR scan. Like vibration analysis, measuring the temperature of a motor at successive intervals helps to identify trends. Misaligned or unbalanced couplings will also show up as “hot” during an IR scan. To avoid false positives, IR scanning should be performed by someone trained in thermography.

The Infraspection Institute provides a “Standard for Infrared Inspection of Electrical Systems and Rotating Equipment” that lists the maximum allowable temperatures for conductors, connectors and terminations, overcurrent devices, bushings, coils and relays, and AC motor windings.⁴⁴

Electrical Motor Diagnostics. Electrical motor diagnostics (EMD) is effective in evaluating the condition of the electric motor circuit. There are several EMD methods. Motor circuit analysis provides information about the winding and ground insulation system and the motor rotor when equipment is de-energized. Motor-current signature analysis provides a Fast Fourier Transform (FFT) spectra and demodulated spectra of current to detect rotor, air-gap, and load-related faults while equipment is energized. FFT is a mathematical technique for efficiently calculating the frequency response of sampled time signals. An electrical signature analysis performed while equipment is energized, provides FFT spectra of both the voltage and current of the motor circuit to detect current-related faults and supply faults.

Maintenance of Stored or Idle Motors

Motors that operate infrequently, such as those in backup applications, should be activated periodically to keep the bearing surfaces lubricated and to prevent problems such as false brinelling. *False brinelling* refers to the indentation of the races or rotating elements (or both) of rolling-element bearings (e.g., ball bearings, roller bearings). This often occurs in motor bearings that remain idle for long periods but that are still subjected to external vibrations.

Keeping a bearing in a static position for a long time results in a loss of the lubrication film that separates the bearing surfaces. The vibrations common to machinery areas promote a brinelling effect at these points of contact. The indentations are usually small. However, when a motor is operating and the bearings are placed under a load, these surface imperfections can lead to poor bearing performance and shorten the motor’s operating life.

To prevent brinelling during shipment, the motor shaft should be securely locked. To prevent brinelling during storage, the shaft should be rotated periodically as part of a preventive maintenance program. To prevent brinelling after installation, the motor should be operated periodically.

⁴⁴www.infraspection.com/useful_guidelines.html

Efficiency Opportunity No. 4: Selecting the Right Motor

An essential component of cost-effective system performance is properly matching a motor type to its application. This requires an understanding of a motor’s operating characteristics and the basic components of a motor system.

Motor Characteristics and Considerations

Several basic operating characteristics are important in properly specifying and operating a motor and drive system. The principal operating characteristics are horsepower (hp), speed, and torque. Other important considerations include efficiency, power supply, motor enclosure, design letter, slip, power factor, and operating temperature.

Horsepower. The horsepower of a motor is the product of its torque and speed. A properly specified motor will match the power requirements of the load over the expected range of operating conditions. However, to correctly specify a motor/drive system, it is usually not sufficient just to match the motor horsepower to the load horsepower. The speed and torque requirements of the driven equipment and the ability of the motor to respond to load changes are important factors in determining how well a motor performs.

The service factor is a multiplier that indicates the percentage of horsepower at which a motor can operate above full load without causing failure under usual operating conditions; common service factor values are 1.1 and 1.15. Relying on the service factor rating of the motor for continuous operation is usually not recommended. In general, the service factor rating applies to short-term or occasional overloads.

Operating a motor above its rated horsepower can shorten the life of its insulation. As a guideline, motor life is reduced by one-half if the motor is operated continuously at the service factor level. Operating a motor at 1.15-rated load increases the winding temperature by about 20°C (depending on factors such as the enclosure type, speed, and elevation), and a motor’s insulation life is halved for every 10°C increase in the heat at which the motor runs. The additional heat in the windings also translates to higher bearing temperatures and can impact lubricant life as well. More information on the service factor is available from EASA.⁴⁵

⁴⁵www.easa.com

Motor life is also reduced by power quality problems such as voltage unbalance, overvoltage, and undervoltage. Because of potential problems with power quality and the uncertainties associated with determining an actual service load, a good rule of thumb is to size motors so that they operate at about 75% of rated load. This practice also usually provides optimum efficiency.

Speed. There are several different ways to configure motor systems to provide effective speed control. Direct-current (DC) motors are frequently selected for applications that require high torque at low speeds; the speed range adjustments of DC motors can go as high as 20:1. The motors can operate as low as 5%-7% of their base speed, and some can even operate at 0 revolutions per minute (RPM).

Some alternating-current (AC) motors, such as wound-rotor motors, also offer effective speed control by controlling the resistance of the rotor circuits. The speed ratios of these motors can also go as high as 20:1. To adjust the resistance of the rotor circuits, these motors are usually equipped with slip rings that connect to external resistance banks.

Large wound-rotor applications can require the use of relatively large resistance banks, such as saltwater rheostats that rely on plates immersed in salt water to provide electric resistance and heat dissipation. More advanced system designs allow wound-rotor motors to regenerate power extracted from the rotor circuit. This regenerated power can be used to drive another motor or can be sent back into the power line. These options increase the efficiency of the speed adjustment process; however, they also increase the complexity, cost, and maintenance requirements of the system. Unless the energy pulled from the rotor circuit is recaptured, the losses associated with operation at slow speeds can increase a plant's energy costs.

AC induction motors can be used in many applications with adjustable speed drives. The most commonly used adjustable speed drive (ASD) is the variable-frequency drive (VFD), and the most common VFD is the pulse-width modulation (PWM) type. These drives are commercially available with an output frequency range from 0 to 120 Hertz (Hz) and can be used to operate motors over a wide range of torques and speeds.

Torque. Torque is the rotational force exerted by the motor shaft. Motors have four principal torque characteristics: starting or locked rotor, full load, pull up (usually the lowest point on the curve), and breakdown. Locked-rotor torque is that developed by the motor at zero speed. Full-load torque is that developed by a motor at its rated

horsepower and speed. Breakdown torque is the highest torque a motor can develop before stalling. Often, this is several times greater than the full-load torque.

Load-Duty Cycle. A system LDC is helpful in choosing the right motor and motor control system (if required). In many systems, loads vary significantly according to the weather, production demand, seasons, and product mix. Therefore, some motors operate normally near their full-load rating, while others operate normally at small portions of their full-load rating. An LDC, shown in figures 10 and 12, is derived from power logging data, and indicates the percentage of time that a motor operates at a given load. A system with a constant load can probably use a general purpose motor without a control system. A varying load may be served best by an inverter-duty motor designed to be used with a VFD equipped with feedback sensors or a general purpose motor with another speed-control device (such as an eddy-current clutch), or a multiple-speed motor.

Efficiency and Losses

The efficiency of general purpose motors has significantly improved in the last 25 years, largely as a result of the efforts of motor manufacturers, with assistance from DOE. For a summary of legislation that has established mandatory minimum full-load efficiency standards for various types of motors, see AMO's *Premium Efficiency Motor Selection and Application Guide*.⁴⁶

The Energy Policy Act (EPAAct) of 1992 required that manufacturers meet a set of energy efficiency motor standard levels for many general purpose motors from 1 hp to 200 hp by 1997. Minimum full-load efficiency requirements for energy-efficient motors are included in Appendix D of this sourcebook. EPAAct has had several effects on the design and performance of motors. To achieve the required efficiency levels, motor manufacturers have had to change the designs of many of their NEMA Design A and B models. These changes have at times included reducing the resistance of the rotor and stator circuits; using electrical-grade steel with improved magnetic characteristics for the stator and rotor laminations to reduce core losses; and redesigning the cooling fan to decrease fan windage losses. Other changes have included designing motors with a smaller slip (higher speed) and using lower-loss core iron. Losses vary among motors of different sizes and designs; Table 2 shows some typical ranges.

⁴⁶ www1.eere.energy.gov/manufacturing/tech_assistance/motors.html

The motor redesign process resulted in slight changes in some motor operating characteristics. Although the initial costs of motors increased 10% to 20% in high-run hour applications, improvements in motor efficiency can result in very favorable payback periods.

Motor AC induction motor efficiencies vary according to several factors, but generally range from 85% to 97% at full load. The primary factors affecting efficiency are speed (high-speed motors tend to be more efficient) and the size of the motor (larger motors tend to be more efficient). Additional factors include type of enclosure (open enclosures tend to be more efficient) and design classification (lower-slip motors tend to be more efficient). Figure 13 shows how efficiency varies with respect to motor horsepower rating and load.

As a rough rule-of-thumb, motor efficiency for many EPAct Design A and B motors is often relatively constant between 70% and 80% of rated load and drops slightly at full load. Motor efficiency may also begin to drop below 50% of rated full load. At loads below 40% of full load, motor efficiency begins to decline dramatically. Slightly oversizing a motor (up to 25%) can actually increase efficiency, but grossly oversizing a motor can lead to substantial efficiency losses. These include not only the energy losses associated with inefficient operation but also increased friction losses in the in-plant distribution system caused by the reduced power factor.

NEMA Premium® Efficiency Motors. The NEMA Premium efficiency motors program defines “premium efficiency” motors as those with higher levels of efficiency than the ones established by EPAct. The NEMA Premium efficiency electric motors program established minimum full-load nominal efficiency values for continuous rated; single-speed; polyphase; 1- to 500-hp; and 2-, 4-, and 6-pole NEMA Design A or B squirrel-cage induction motors. Appendix C in this sourcebook shows the NEMA Premium efficiency standard levels for each motor type, size, and speed.

With the enactment of the Energy Independence and Security Act (EISA) of 2007, the mandatory minimum nominal full-load efficiency for low-voltage general-purpose motors with a power rating up to 200 hp was raised to the premium efficiency level as given in Table 12-12 of NEMA MG 1-2011. The mandatory EISA premium efficiency requirement applies to motors purchased alone, imported into the country, or purchased as a component of another piece of equipment.

Table 2. Sources of Motor Losses

Friction and Windage	5%–15%
Core (Iron) Losses	15%–25%
Stator (I ² R)	25%–40%
Rotor (I ² R)	15%–25%
Stray Load	10%–20%

EISA also requires that NEMA Design B motors with power ratings between 201 and 500 hp shall have a full-load efficiency that meets or exceeds the NEMA energy-efficient motor standards (given in Table 12-11 of NEMA MG 1-2011). End-users may voluntarily purchase NEMA Premium efficiency motors with these ratings. The EISA motor efficiency mandates took effect in December 2010.

EISA also expanded the term “general purpose” motor to include a number of motor subtypes that were not covered by the earlier EPAct motor efficiency standards. These motors now must have full-load efficiency values that

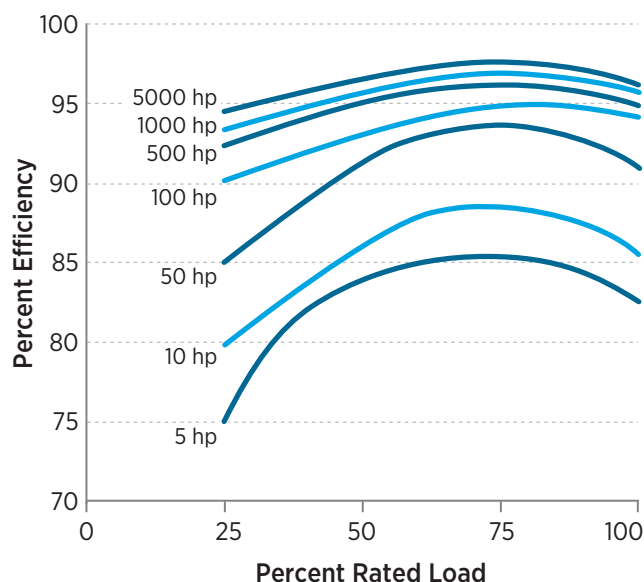

Figure 13. Typical AC polyphase motor efficiency vs. load (1,800 rpm)

meet or exceed the NEMA energy-efficient motor standards. Motors within 1-200 hp that are covered by this mandatory efficiency standard include:

- U-Frame motors
- Design C motors
- Closed-coupled pump motors
- Footless (C-face or D-flange without base) motors
- Vertical, solid-shaft, normal-thrust motors (P-base)
- 8-pole (900 RPM) motors
- Polyphase motors with a voltage of not more than 600 V (other than 230- or 460-V motors). This applies to 200- and 575-V motor model lines
- Fire-pump motors.

Design Classifications

NEMA has established several different motor classifications that reflect the speed and torque characteristics of induction motors. These characteristics are shown in Figure 14.

Design A. This type of motor is used primarily in special applications for which a comparable Design B motor would not have a high enough breakdown torque. In addition to higher breakdown torques, Design A motors usually have higher starting currents and less slip than Design B motors. This motor is usually selected for applications requiring high, transient increases in load. It can be a manufacturer’s most efficient motor solution and is often selected because of its efficiency advantages. Typical applications are injection molding machines, crushers, and air compressors.

Design B. This type of motor is similar to a Design A motor and is the most common type—a true industry workhorse. In fact, the operating characteristics of Design B motors are often compared with those of other motor designs to provide a practical perspective. Consequently, Design B motors have normal starting torques, normal breakdown torques, and moderate slip characteristics. Typical applications are pumps, fans, and air compressors.

Design C. This type is characterized by high torques and is often used in high-inertia applications. These motors are slightly less efficient than comparable Design B motors. Design C motors are often selected for applications requiring high-starting torques. For example, positive

displacement pumps and refrigeration compressors often start against high back pressures and therefore require high-starting torques. To meet this starting torque, a relatively large Design B motor would be required, but a more properly sized Design C motor would be more cost-effective. Typical applications are material handling systems such as conveyors.

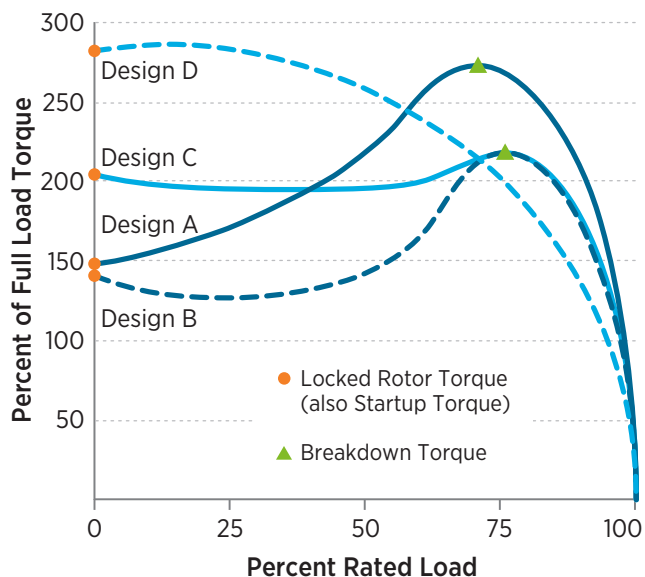

Figure 14. Torque and speed characteristics of various types of motors

Design D. This type has very high-starting torques and high-slip characteristics, ranging from 5% to 13%. These motors are generally used in high-transient, cyclical load applications such as punch presses. Because of their high-slip characteristics, they are somewhat less efficient than the other classes. Oil well pumps are often powered by Design D motors because the load is cyclic, and there is a relatively large difference between the highest and the lowest torques in the cycle. A high-slip motor operates evenly within this load cycle; consequently, efficiency losses are balanced by the reduced electrical stress on the system resulting from lower current surges. Applications include systems with sudden load changes, such as hoists and punch presses.

Major Specification Characteristics

It is important to determine the voltage and enclosure needed when specifying an industrial motor. The voltage is usually determined by the power available in the plant's distribution system. The enclosure type is usually determined by environmental conditions such as air quality, exposure to moisture, any harmful vapors present, and so on.

Voltage. The voltage rating of a motor should match the power supply. Common motor voltages are 115, 200, 230, 460, 575, 2,300, and 4,000 V. Motors rated for 600 V and below are called “low-voltage” motors, while the 2,300 and 4,000 V motors are deemed “medium-voltage” motors. Motors are relatively sensitive to the power supply voltage, but the motor voltage often does not precisely match the voltage rating of the power supply because of anticipated voltage drops in the distribution system. Line voltages can vary according to the utility supply, plant loads, power factor effects, and the performance of the transformer. It is important to understand the effects of these variables on the operation of a motor.

Decreasing the line voltage usually increases the current required by a motor to meet a particular load, except in cases of light loads. This higher current generates more heat and losses in the motor windings and decreases a motor's operating efficiency. Prolonged operation at low voltages will shorten a motor's operating life. To protect against potential damage caused by operating a motor at low voltages, some motors are equipped with an undervoltage relay that de-energizes the motor in response to low-voltage conditions. In fact, plants that experience frequent voltage sags often experience problems caused by the activation of these undervoltage relays. Motors are also subject to transient voltage events, such as surges and sags. These events can be triggered by utility switching or in-plant activities such as the energization of large loads.

Line voltage that is higher than a motor's rating can also affect the motor's life and performance. Depending on the design of the motor, overvoltage conditions can cause magnetic saturation of the iron core that can lead to overheating of the motor. However, for voltages up to 110% of the motor's rating, the full-load efficiency of the motor might actually increase up to 1% as a result of the lower current required. Also, at 110% of a motor's rated voltage, startup and maximum running torques can increase more than 20%. Operation at high voltage can also decrease the

power factor and increase the operating speed. For centrifugal loads, such as pumps and fans, the result can be an increase in energy use.

For additional information on motor operation in abnormal operating conditions, see Chapter 5 of AMO's *Premium Efficiency Motor Selection and Application Guide*.⁴⁷

Enclosure Type. The enclosure refers to the motor's level of protection from its environment. Table 3 contains a list of enclosure types. Because motors are sensitive to temperature, moisture, and contaminants, the proper enclosure must be selected for the motor to operate properly.

Bearings. Bearings are essential to the operation of a motor. When selecting a motor, it is important to ensure that the bearings are compatible with the load, temperature, and environmental conditions. In industrial motor applications, the most common bearing types are journal (sleeve) bearings and rolling-element bearings. Rolling-element bearings rely on the action of balls or rollers to minimize friction while supporting the load. Journal bearings usually use a lubricant film to separate the metal surfaces and thus reduce friction. Because different bearing designs have different lubrication requirements, it is important to follow the manufacturer's guidelines on lubrication procedures. Insulated bearings may be required for VFD applications to protect against bearing damage from the shaft voltage.

Compatibility with Inverter Drives. In VFD applications, especially those that use PWM voltage waveforms, motor windings are exposed to short-duration, over-voltage spikes that can shorten their lives. These pulses are caused by switching in the power electronics. Inverter-duty motors are specifically designed to handle the stresses of service with PWM inverters, and most motor manufacturers offer them. Insulation and winding placement are also improved. Many manufacturers also offer inverter-friendly features in their premium efficiency motors. For additional information, see the AMO Energy Tips sheet, *When Should Inverter-Duty Motors be Specified?*⁴⁸

⁴⁷ www1.eere.energy.gov/manufacturing/tech_assistance/motors.html

⁴⁸ www.eere.energy.gov/manufacturing/tech_deployment/pdfs/motor_tip_sheet14.pdf

Table 3. Common Types of Enclosures

Enclosure Type		Characteristics
Open	Drip-proof	Can withstand dripping liquids up to 15° off vertical
	Splash-proof	Can withstand splashing liquids up to 100° off vertical
	Guarded	Ventilation openings are less than ¾ in. wide
	Externally ventilated	Ventilation is provided by a separate motor-driven fan
Totally Enclosed	Unventilated	Does not contain a means of external cooling
	Fan-cooled	Contains an integral fan
	Explosion-proof	Will not ignite an external gas
	Waterproof	Excludes leakage

Common Problems

Motors can experience both mechanical and electrical damage. Mechanical damage includes bearing failure, and approximately two-thirds of all motor failures involve bearings.⁴⁹ In severe cases, bearings can seize as a result of a loss of lubrication or entrainment of solid contaminants. Because bearing failure usually results from the breakdown of lubrication, users should carefully consider the service and lubrication requirements of bearings when selecting a motor. Selecting the proper bearings depends on the load, temperature, environmental conditions, speed, coupling method, lubricant method, and the frequency of motor starts and stops.

Electrical damage has many causes and is evident in an insulation failure. An insulation failure usually causes a fault, such as a ground or a short. Grounding problems occur when a winding directly contacts a ground path. Faults can occur between windings of different phases or between different winding turns on the same phase or coil.

Winding failures account for about one-fifth of all motor failures.⁵⁰

The causes of insulation failure include the high temperatures caused by a current overload and voltages that exceed the dielectric strength of the insulation. Even under normal conditions, winding insulation ages over time; however, heat accelerates this breakdown rate. Under normal operating conditions, most insulation classes are rated for a certain operating temperature (which varies according to the insulation class) and a certain theoretical operating life (typically 20,000 hours). Several conditions can cause high winding temperatures, including low-voltage conditions and high motor loads. Conditions that impair the dissipation of heat—such as the contaminants that can build up on windings, motor surfaces, and fan blades—can also increase winding temperatures by reducing the amount of heat transferred away from the motor.

The induced bearing currents associated with PWM drives can also degrade bearings. This issue is discussed further in “Efficiency Opportunity No. 5: Using Variable Frequency Drives.”

⁴⁹Bonnett, A.H.; Yung, C. (2006) “A Construction, Performance and Reliability Comparison for Pre-EPA, EPA and Premium-Efficient Motors.” *Petroleum and Chemical Industry Conference*; Sept. 11-15, 2006, Philadelphia, PA. Accessed Sept. 10, 2013: <http://ieeexplore.ieee.org/xpl/articleDetails.jsp?arnumber=4199051>.

⁵⁰ *ibid*

Efficiency Opportunity No. 5: Using Variable Frequency Drives

The advantages and benefits of motor speed control include lower system energy costs, improved system reliability, fewer maintenance requirements, and more effective process control. Many applications require accurate control of a motor's operating speed. Historically, DC motors have been used in these applications because of their effective speed control characteristics. However, as a result of improvements in power semiconductor technology, the current practice in industry is to use VFDs with AC motors.

Some competing ASD technologies, such as hydraulic couplings and eddy-current drives, offer similar advantages in terms of speed control. However, VFDs have substantial advantages in comparison to other speed control options. VFDs are highly efficient, reliable, and flexible; and motor users can bypass them for maintenance or repairs without having to take the motor out of service. But VFDs are not recommended for all motor/drive applications, so understanding their performance and application is essential in deciding whether to use them.

Common Applications

VFDs are used in a wide range of applications, including fluid (gas and liquid) systems, material handling systems, and machining and fabrication processes. These drives can be incorporated into closed-loop control systems, and VFD speed adjustment ratios are similar to those of other speed control systems. The principal advantage of VFDs is improved operating efficiency, which means substantial cost savings in many motor systems. If they are used in place of mechanical drive options, VFDs can also improve system reliability by removing potential failure modes and requiring less maintenance because they have fewer components.

Fluid Systems. Because they can save a significant amount of energy, VFDs are well suited for fluid systems. In fan systems and systems served by centrifugal pumps with low static head requirements, there is a cube power relationship between flow and power (see the discussion of affinity laws in Section 1). Because many fluid systems have varying flow requirements, a VFD can adjust the output of a pump or a fan to meet these requirements automatically.

VFDs can often be retrofitted to existing pump and fan motors; however, all existing motors should be evaluated for compatibility with this modification. But, even if the motor must be changed, other system components can be left intact, which makes this upgrade relatively nondisruptive.

VFDs can provide substantial flow-control improvements and reduce the stress on the entire system. Unlike other flow control measures, such as throttle and bypass valves, which dissipate energy after they are added to the system fluid, VFDs reduce the amount of energy imparted to the system. This reduction also reduces stress on the piping system and support structures. VFDs are not suitable for all fluid system applications, and may not be cost effective in systems with low annual operating hours, that use other flow control approaches such as eddy current drives, multi-speed motors, multiple pumps working in parallel, or in high static lift applications where on/off control may be effective.

Material Handling Systems. In material handling applications, VFDs allow better control of transport, mixing, and packaging processes. Conventional control processes use bypass or on-off controls to modulate the movement of work-in-process. However, bypass methods similar to those used in fluid systems tend to be wasteful. And, on-off methods tend to impose stresses on the system as material is abruptly stopped, then started. In contrast, VFDs allow the speed of a process or a feed stream to be slowed or accelerated according to an automated feedback signal. This can improve the quality of the finished product.

For example, VFDs are often used to control the speed of the winding machines in aluminum mills and paper plants. Using a signal that directly measures line speed, a VFD controls the rotation of the winder to maintain a constant process speed. In contrast, using a brake to control the winding speed results in a loss of energy. Using a brake also requires the use of a motor with large slip characteristics and increases system maintenance requirements.

Machining and Fabrication. Most machining and fabrication applications use constant speed AC motors. The operating life of tools and cutting bits is highly sensitive to how well and constantly the cutting speed and pressure are maintained during machining operations. In this regard, VFDs offer several advantages. Conventional speed-control options use gears or pulleys to maintain the cutting speed within a certain range; however, these devices have limited flexibility. Usually, speeds must be selected when the machine is being set up for the task. In contrast, VFDs can control the cutting speed continuously during the machine operation and can shift to different speeds without requiring the machine to be reconfigured. In many machining operations, VFDs can improve the process control and the speed of production, demonstrating that energy savings are not the only benefit of this technology.

Alternatives

There are two principal ways to adjust the speed of motor-driven equipment:

- Adjust the speed of the motor directly
- Use a constant-speed motor with an intermediate device between the motor and the driven equipment that can change the speed ratio.

Historically, when direct control of the motor speed was required, designers had to use DC motors or AC wound-rotor motors. Although each type has advantages, they also have drawbacks in terms of maintenance and efficiency. For example, DC motors are relatively expensive, need more maintenance, and require a means of generating DC power. Wound-rotor motors add resistance to the rotor circuit for speed control, which is inefficient unless a comparatively complex recovery system is used.

Using an intermediate speed-adjustment device, such as a gearing system or an adjustable pitch-pulley system, adds another component to the motor/drive system. These components increase the risk of failure and increase efficiency losses.

Mechanical. Gear systems allow different speed ratios between the motor and the driven equipment; however, the speed ratio is usually fixed. Although clutch devices can allow shifting between different gears to achieve different speed ratios, these systems are limited to discrete speed changes that often interrupt a machine's operation.

Enclosed gearboxes are essentially speed reducers and torque multipliers. A right angle gearmotor can also be used to change the direction of a drivetrain. The gearboxes may either be coupled to a motor with a C-face adapter or made to be integral. Enclosed gearing can multiply the torque needed to drive a load, thus reducing the size of the motor required and potentially saving energy.

Gears are often used as speed reducers because most applications require a slower speed than motors with multiple poles can economically provide. Gears are used to match the design speed of the driven equipment, so it performs at an optimum efficiency level. They also help to absorb the mismatch in inertia between the load and motor, thus allowing a controlled stop during the deceleration phase when used with a VFD.

Worm, helical, bevel, and combination gear reducers are commonly used in industry. When considering the use

of a gearbox in a system, engineers need to keep in mind that there is an efficiency loss that varies by gear type and gear ratio (the ratio of the input shaft speed to the output shaft speed). This efficiency loss must be taken into consideration, but their overall contribution still may be advantageous.

Belt systems are similar to gear systems in that various combinations of pulleys can be used to achieve different speed ratios. Most belt systems use fixed pulleys that can be changed; although, doing so requires securing the system and replacing one or more pulleys. This tends to be highly disruptive to the operation of the equipment. Some belt systems allow speed ratios to be continuously adjusted. The pulleys in these systems have a varying pitch angle that changes the speed ratio when the pulley is moved in or out. However, because of side wear on the belts, these systems tend to require a lot of maintenance and are subject to reliability problems. For additional information on gear and belted power transmission system efficiency measures, see Chapter 8 of AMO's *Continuous Energy Improvement in Motor Driven Systems*.⁵¹

Hydraulic couplings work like a centrifugal pump, allowing speed to be adjusted continuously by controlling the amount of slippage. Although these systems adjust speeds during system operation, they are inherently inefficient. The energy lost because of increases in the amount of hydraulic slip is essentially unrecoverable.

Magnetic ASDs use rare-earth magnets to transmit torque from a motor to a load. Making use of the principle of magnetic induction, they consist of two components that do not come in physical contact with one another. A rotor assembly containing permanent magnets is mounted on the load shaft, and a conductor assembly with copper rings is connected to the motor shaft. The relative motion between the magnets and the copper rings creates a magnetic field that transmits torque through the air gap. Varying the width of the gap changes the coupling force, producing an infinitely variable output speed. For additional information on magnetic couplings, see the AMO motor Energy Tips sheet, *Magnetically Coupled Adjustable Speed Motor Drives*.⁵²

⁵¹ www1.eere.energy.gov/manufacturing/tech_assistance/motors.html

⁵² www.eere.energy.gov/manufacturing/tech_deployment/pdfs/motor_tip_sheet13.pdf

Electrical. Eddy-current couplings allow speed to be adjusted continuously by controlling the strength of the magnetic field between the driver and driven component. Strengthening the field transfers more torque from the driver to the driven element while decreasing the field strength; this allows greater slip between the two. Eddy-current couplings provide effective speed control; however, they result in comparatively high heat loss and are typically less efficient than VFDs. Eddy-current clutches can also be maintenance intensive; for the most part, they have been replaced by VFDs. For additional information, see the AMO Energy Systems Tip Sheet *Is it Cost-Effective to Replace Old Eddy-Current Drives?*⁵³

Competitive Advantages

Depending on the application, VFDs have many benefits and provide numerous advantages over other control methods. For example, using VFDs in pumping and fan systems provides far greater energy savings than other flow control options, such as throttling and bypass. These advantages are discussed in more detail in *Improving Pumping System Performance: A Sourcebook for Industry*⁵⁴; and *Improving Fan System Performance: A Sourcebook for Industry*.⁵⁵

Misapplications

VFDs are not recommended for applications in which slowing down the machine speed causes operating problems, such as insufficient torque or poor cooling. In pumping systems that have high-static head characteristics, slowing down the pump speed too much can force the pump to operate in a virtual shut-off head condition. Under these conditions, the pump can experience damaging vibrations and could fail to provide adequate flow to the system.

Similarly, in applications in which the torque increases at low speeds, such as certain mixing processes, the power requirements of the motor will not drop significantly at lower speeds. In such cases, the integral motor fan may not provide sufficient cooling at lower speeds. In applications in which torque decreases with speed, this concern is not as important because the windings generate less heat. However, in some constant horsepower applications,

additional cooling may be required to prevent the motor from overheating. In these cases, a cooling fan powered by its own motor is used.

VFD control for rotary screw air compressors is becoming common. These systems work well as trim compressors and in plants with variable compressed air requirements or with greatly reduced requirements during cleanup shifts or on weekends. VFDs cannot be used with large centrifugal compressors because they cannot provide their rated pressure at reduced speed.

The load characteristics of other machinery, such as positive displacement pumps, often do not favor the use of VFDs. In these applications, the linear relationship between output, power, and equipment speed tends to favor other control technologies.

Bearing Currents. In some VFD applications, motors experience bearing problems caused by current that travels through the bearing. The cause of these problems is the induction of a slight voltage in the shaft of a motor or its driven equipment. Because VFDs tend to generate harmonics in the power supply to the motor, the harmonics could contribute to the induced shaft voltage. In applications in which the shaft is connected to a ground source (for example, a pumping system) that provides a better discharge path for the voltage, bearing currents are generally not a problem. In other applications, the induced voltage discharges through the bearings, creating degradation problems. Although this current is relatively small, it can cause pitting on the bearing races and rolling elements, and this pitting can cause increased wear rates under load.

One of the most common ways to avoid bearing current problems is to select or retrofit motors with insulated bearings. Insulated bearings on the motor could move bearing current issues downstream to the driven equipment. Another option involves equipping the shaft with a grounding brush to provide an alternate path for the shaft voltage discharge. While effective at reducing bearing currents, the grounding brush must be maintained, which often means replacing the element every three months.

Newer technologies are always being developed. One of the latest in the motor industry is the microfiber brush, which has been used on copying machines for years. This technology eliminates drag and requires minimal maintenance. Finally, the use of electrochemical grease is

⁵³ www.nrel.gov/docs/fy13osti/56009.pdf

⁵⁴ www.eere.energy.gov/manufacturing/tech_deployment/pdfs/pump.pdf

⁵⁵ www.eere.energy.gov/manufacturing/tech_deployment/pdfs/fan_sourcebook.pdf

recommended for some applications. This grease provides a ground path that can remove enough current to protect the bearing. For additional information on VFD/motor interactions, review the ‘Effects of Adjustable Speed Drives on Induction Motors’ section in the AMO’s *Premium Efficiency Motor Selection and Application Guide*.⁵⁶

Power Quality Effects. Some VFDs, especially PWM types, create rapid-rise-time pulses (spikes) in the voltage waveform. The pulses have a very steep leading edge or rapid change of voltage with time. A voltage with a high rate of change is unevenly distributed along the motor’s windings. The most harmful effect occurs when the motor feeder cable is relatively long. The inductance of a long motor feeder cable may create a resonance in the drive-cable-motor circuit. A reflected voltage wave may appear at motor terminals. When the voltage changes from zero to its full value, there can be an overshoot at the motor terminals of more than twice the normal value.

Almost half of that overshoot can be dropped across the first turn of the first coil of the motor stator winding. The turn-to-turn insulation is designed for only a few volts, and the overshoot voltage causes a discharge between the turns of the winding. Over time, this discharge can cause winding damage and premature failure of the motor.

There are several solutions to this problem. A choke, or inductor, can be placed on the output of the drive, a capacitor can be placed in parallel with the motor, or an L-C filter—a low-pass filter that consists of an inductance (L) and a capacitance (C)—can be placed at the drive output.

It is important to note that motor manufacturers have developed an insulation classification known as “inverter-duty,” which is much more resistant to voltage pulses. Normally, inverter-duty motors should be used in PWM applications, although many manufacturers offer “inverter-friendly” insulation in their premium efficiency motors. Motor users should always consult the drive manual when using long motor feeder cables to ensure that the cables do not exceed the maximum recommended length. For additional information on voltage overshoot and mitigation techniques, see the AMO’s Energy Tips sheet *Minimize Adverse Motor and Adjustable Speed Drive Interactions*.⁵⁷

For additional information regarding control of general purpose motors with VFDs and on inverter-duty motor design and performance capabilities, see NEMA’s *Application Guide for AC Adjustable Speed Drive Systems*.⁵⁸ NEMA MG 1-2011⁵⁹ Part 30 provides performance standards for general-purpose motors used with VFDs. For information on inverter-duty motors, review Part 31, *Definite-Purpose Inverter-Fed Polyphase Motors*.

Efficiency Opportunity No. 6: Addressing In-Plant Electrical Distribution and Power Quality Issues

Motor system performance can be adversely affected by poorly designed and maintained in-plant electrical distribution systems as well as from power quality issues. Power quality issues are usually expressed in deviations in voltage, current, or frequency, and they can cause equipment operation problems or even failure. Today’s sophisticated motor systems employ newer technologies such as soft-starters, drives, and stepper motors along with programmable-logic controllers; these motor systems are often sensitive to and affected by poor power quality.

Power quality is a growing concern in industry as more processes are being automated and more computers are being used to control and monitor equipment. Because digital equipment often must be reset or resynchronized after a power disturbance, the issue of power quality merits close attention.

For some processes, power problems can be quite costly. For example, in plastics extrusion processes, there is a risk that plastics or resins might solidify in production equipment during a process interruption. Clearing the equipment of solidified plastics can be costly and time-consuming. In pharmaceutical and other mixing or time-sensitive processes, expensive batches can be lost if a power quality problem strikes at the wrong time.

In addition, a common trend in many energy efficiency programs is to upgrade interior lights to high-intensity discharge (HID) lighting. It can take several minutes for a ballast to bring these lights up to normal intensity.

⁵⁶ www1.eere.energy.gov/manufacturing/tech_assistance/motors.html

⁵⁷ www.eere.energy.gov/manufacturing/tech_deployment/pdfs/motor_tip_sheet15.pdf

⁵⁸ www.nema.org/Standards/Pages/Application-Guide-for-AC-Adjustable-Speed-Drive-Systems.aspx

⁵⁹ www.nema.org/standards/Pages/Motors-and-Generators.aspx

Consequently, a momentary loss of power can result in a lengthy delay in restoring adequate light. In fact, in emergency lighting applications, HID lighting systems must be supplemented by other lights to ensure safety.

These are the primary problems associated with in-plant electric distribution systems and power quality:

- Voltage problems, including outages, sags, transients and surges, harmonics, and other signal distortions
- Poor power factor
- Electromagnetic interference.

Finding solutions to these problems and correcting them can lower a plant's energy bills, reduce fire hazards, increase equipment life, and reduce downtime. Motor and drive systems that are intelligently configured and well-maintained are less likely to cause distribution system problems. Understanding the impact that motors have on the performance of a facility's electrical distribution system (and vice-versa) can help improve an industrial plant's overall operation.

Voltage Problems

Voltage problems—which include outages, sags, surges, and unbalances—are basically any deviations in a normal waveform. The consequences of voltage problems range from reduced performance characteristics to motor damage to complete motor failure. Because motor failure may interrupt a process—requiring replacement of the motor and restarting, and perhaps resynchronizing the entire system—understanding common causes of outages and sags can prevent costly production problems. Sizing motors to operate at 80% voltage is a major cause of oversizing.

Outages. Outages, the most noticeable problem, can be momentary power losses caused by faults from either internal or external events. Faults that cause momentary power losses are usually cleared quickly. For example, wind might cause a power line to contact a ground source, causing an overcurrent condition that activates protective switchgear. However, once the fault is cleared, the switchgear can realign to provide power. Long-term outages are usually the result of a line problem, such as a damaged power line or the catastrophic failure of a transformer or switchgear component.

Outages can also be part of a utility's strategy to manage loads during high-demand periods. To prevent one area

from losing power for an extended period, some utilities use rolling brownouts to manage their capacity.

Sags. A voltage sag is a decrease in the magnitude of voltage from 10% to 90% that lasts anywhere from half a cycle up to five minutes. Voltage sags can be caused by utility system events such as faults created by equipment failure, lightning, and equipment contact with trees or vehicles. Voltage sags are most often caused by in-plant events or activities at a neighboring facility that pull large currents.

Motors with large starting currents can create voltage sags, especially if the motor is large relative to the capacity of the distribution system. Voltage sags can cause protective devices such as relays to de-energize, and they can also create problems with process control equipment. Facilities with low-power factors often experience voltage sags caused by the high-current levels in the distribution system.

Voltage sags often cause problems with PWM types of VFDs. However, drives can be specified to have an adequate ride-through capability if the duration and magnitude of the expected sag are known. Power quality monitors can be installed to record troublesome sags and to identify their source and duration.

Overvoltage and Undervoltage. Motors are designed to operate with $\pm 10\%$ of their rated voltage. However, even within this range, changes in the voltage supplied can affect a motor's performance, efficiency, and power factor. Ideally, deviations in the voltage supplied to a motor system should be less than $\pm 2\%$.

Changes in the voltage supplied to induction motors can affect their performance significantly. For example, a 10% decrease in the voltage supplied to a Design B induction motor decreases its torque by almost 20% while increasing its rated slip by more than 20%. Another consequence of low voltages is the increased current draw that the motor requires to meet the power requirement. In fact, many motor controls are equipped with an undervoltage relay that de-energizes the motor under low-voltage conditions to prevent damage from the high current draw.

Conversely, increasing the motor's voltage by 10% improves some operating characteristics of the motor, such as its torque. However, the effect of overvoltage on motor efficiency depends on the motor's load. The motor's efficiency can increase when the line voltage is up to 10% higher than the rated voltage, but at part load the efficiency could decrease.

Voltage deviations can be caused by any of the following factors:

- Changes in loads associated with daytime, nighttime, and seasonal operation
- Improperly sized transformers
- Undersized conductors
- Poor connections
- Sources of low power factor in the distribution system.

These problems can be caused by sources within the plant or by the power supplier. Most utilities have standards for the power supplied to a customer’s facility; a typical voltage standard is $\pm 5\%$. When a customer questions whether these standards are being met, a utility will often monitor the power supplied to the plant. Although facilities can sometimes be affected by power disturbances caused by neighboring customers, plants that experience voltage problems should first perform an internal review to determine if an internal source is responsible. System voltages can sometimes be corrected by adjusting transformer tap settings, installing automatic tap changing equipment, or installing power factor correction capacitors.

Seasonal changes also affect the power supply. In hot weather, utilities usually increase voltage levels to handle anticipated increases in cooling loads from air conditioners, chillers, and so on. However, these increases should remain within the tolerances specified by the utility in its power supply agreement. For additional information on tuning your in-plant distribution system, see the ‘Industrial Electrical Systems’ chapter in AMO’s *Premium Efficiency Motor Selection and Application Guide*.⁶⁰

Unbalances. Three-phase electrical systems should have three vectors, each one of equal magnitude and out of phase by 120° . A nonsymmetrical—or unbalanced—system is so called because of differences between any two of the three phases. A voltage unbalance results in a current unbalance, which can significantly reduce the efficiency of a motor. An unbalance will also reduce the life of the motor because of the excess heat generated in the stator and rotor assembly.

Voltage unbalance can be caused by:

- The power supplier
- A nonsymmetrical distribution of single-phase loads, in which a disproportionate share of single-phase loads is placed on one of the three phases
- An open circuit on one phase
- Different-sized cables carrying the three phases
- Selection of the wrong taps on the distribution transformer
- Single-phase loads that create low-power factors.

When a voltage unbalance reaches 5%, the phase currents can differ by as much as 40%. This type of power supply unbalance can quickly lead to motor damage or failure. Therefore, phase voltages in a plant should be monitored, and if the unbalance exceeds 1%, corrective action should be taken.

Methods for correcting unbalanced voltages include redistributing single-phase loads or having the utility correct the supply voltage unbalance. NEMA Standard MG1 provides specific guidance on the motor derating factors used for various levels of voltage unbalance. The derating factors require the motors to be operated at greatly reduced loads. The overall effects of voltage unbalance on the performance, efficiency, and life of a motor are negative.

Transients and Surges. Transients and surges are often the result of a large switching activity, such as energizing capacitor banks. In areas with large inductive loads, utilities will energize capacitor banks to increase the power factor, improve voltage, and reduce the system stresses that accompany large reactive loads. Unfortunately, energizing these capacitor banks can create transient voltage surges that affect sensitive equipment.

Lightning is another common cause of transients. The enormous amount of energy in a lightning strike can destroy controllers and equipment. Proper system grounding is essential to minimize the risk of equipment damage; however, sensitive equipment such as computers and automated control systems usually require additional protection. Dedicated transient voltage-surge suppression (TVSS) devices are recommended for highly sensitive equipment.

Harmonics. Harmonics are a form of signal distortion in which whole-number multiples of the main frequency are

⁶⁰ www1.eere.energy.gov/manufacturing/tech_assistance/motors.html

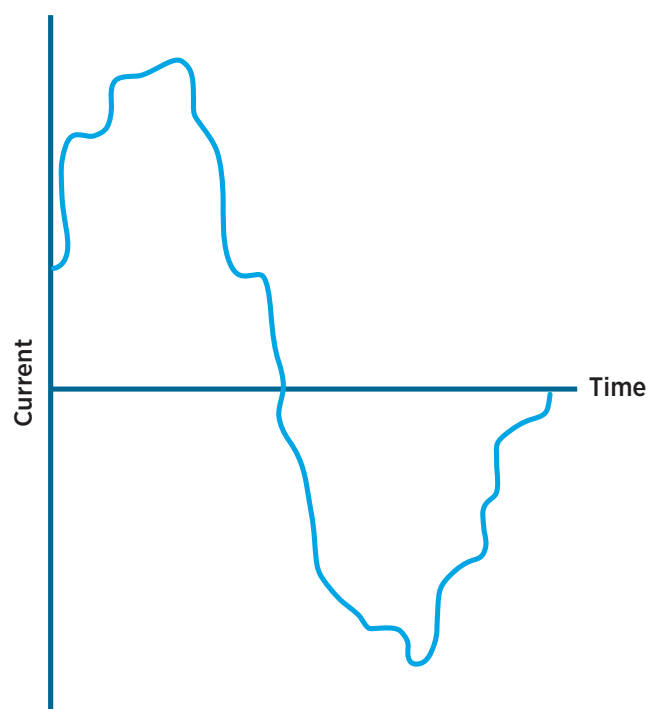

Figure 15. Waveform distorted by harmonic effects

superimposed on the 60-Hz waveform. When multiples of the fundamental are added in, they create a jagged appearance to the sine wave. A common multiple is the fifth harmonic, or 300 Hz. A sine wave with a fifth harmonic has a stair-step pattern. Figure 15 shows a wave with about 8% fifth harmonic. Harmonics negatively affect the performance of inductive machines such as transformers and induction motors. Harmonics can also interfere with the accuracy of sensitive control equipment.

The harmonic content in a power signal is usually measured in terms of total harmonic distortion (THD), as defined by IEEE Standard 519. Electrical equipment is often rated to handle a certain amount of THD (a common value is 5%). Harmonics are created by large nonlinear loads such as welders and VFDs. VFDs generate harmonic signals that affect both the incoming power supply and the power signal sent to the motors. To minimize the effect of harmonics, many facilities install filtering devices and isolation transformers with VFDs.

Harmonics increase the amount of heat generated in motor windings for a particular load. However, motors are typically much less sensitive to harmonics than computers or communication systems. NEMA has developed a special

measure of harmonic distortion for motors called the *harmonic voltage factor*, which is defined in NEMA MG1.

The reactance of the line between the drive and the motor can contribute to a resonance that increases harmonic distortion. Consequently, as a rule of thumb, the line length between a VFD and a motor should be as short as possible.

Power Factor

Power factor is the ratio of real (working) power to apparent (total) power. Many electric utility companies charge additional fees (power factor penalties) if the power factor of the plant falls below 0.90 or 0.95. Because a typical induction motor operates at around 85% power factor, many facilities with large motor systems and low-power factors face stiff power factor penalties if correction is not applied.

Low-power factor problems result mainly from the high-line currents required to meet the real power demand. The increased current flow causes resistive losses, which waste energy. Reactive power loads also reduce the in-plant electric distribution system's capacity by creating an additional voltage drop that can cause equipment to perform poorly.

Low-power factor can also be caused by idling or lightly loaded motors and by operating equipment at above the rated voltage. A low-power factor can be corrected by installing capacitors at a particular motor, at a motor control center for a series of motors, or at the utility point of delivery, whichever is more appropriate. In some facilities, large synchronous motors are used to add a leading-power factor component to the distribution system. For additional information about power factor penalties and correction, see Chapter 9 of AMO's *Continuous Energy Improvement in Motor Driven Systems*.

Electromagnetic Interference

PWM types of VFDs can generate significant levels of electromagnetic interference (EMI), or *noise*, that is both radiated from the drive and conducted in conduit, cable tray, and ground wires. This noise is generated by high-frequency switching of the voltage. Because the switching is so rapid, the noise can be in the megahertz range. At these high frequencies, noise couples easily into grounding conductors. The noise can cause failures in electronic circuits such as computers, control circuits, and communications.

There are several ways to mitigate this noise; one is to use a common choke mode or filter on the output of the drive. Another is to enclose the entire motor feeder in metal conduit, from the drive to the motor.

Solutions

Although a properly designed system should not create power quality problems, several factors can degrade a system's ability to maintain proper voltage and current during internal or external events. For example, adding single-phase loads to one phase of the distribution system can create a voltage unbalance among the phases that leads to poor motor performance. Degradation of the grounding system can also interfere with equipment operation or prevent fault-clearing devices from working properly. Capable electrical contractors or an electric utility can perform a site survey to determine whether the grounding system is adequate. A fundamental way to avoid many power quality problems is to review the capacity of the system before adding new loads.

Facilities that have problems with equipment overheating, controllers that operate poorly, frequent sags, and so on should perform a power quality review. This can help plants locate the causes of problems and find cost-effective resolutions. As plants become increasingly automated, there is also an increase in the amount of equipment subject to power quality problems. Therefore, methods that help prevent such problems are worth considering. Hand-held power quality monitoring devices are becoming quite inexpensive. Many hand-held devices can record voltage and current waveforms that can be played back later on a personal computer for further analysis.

Soft-Starting Devices. Energizing large motors with “across-the-line” starting usually creates a large in-rush current, often six to eight times that of the normal operating current. Startup currents like those can cause voltage sags and other power quality problems. In fact, premium efficiency motors have actually increased the frequency of starting current problems. The efficiency gains obtained with newer motors derive largely from a reduction in the rotor circuit resistance, compared to that of older, conventional motors. Thus, the starting torques of the new motors are lower, and the starting currents are higher.

The electrical system stresses caused by starting large motors have prompted a demand for equipment that “softens” motor start-ups. The purpose of soft-starting equipment is to limit the starting current. Types of soft-starters include special motor controllers and most VFDs, which

can usually limit starting currents to one and one-half to two times the motor's rated operating current.

Transient Voltage Surge Suppressors. TVSSs are designed to prevent sudden voltage surges from damaging sensitive equipment such as computers, numerically controlled equipment, controllers, and instrumentation. These devices usually contain metal-oxide varistors configured to provide a path for current to flow away from the equipment during a transient event. TVSSs afford protection from both highly damaging voltage surges and the less noticeable transients, which do not cause an immediate equipment failure but do increase the cumulative wear on the equipment, shortening its operating life. TVSSs should indicate visually that all elements are still working. And, like any piece of electrical equipment, they have a finite life.

Isolation Transformers. Typically, isolation transformers are used to filter damaging signal surges, noise, and harmonics to prevent them from reaching sensitive equipment. These devices are almost always used with VFDs of more than 1,000 hp, but they are also often used with smaller VFD applications. The drawbacks of these devices include added equipment and installation costs, slight efficiency losses, the introduction of another possible failure mode, and the additional maintenance required for the transformer.

Filters. Sophisticated filtering devices are often used with VFDs to prevent high-frequency harmonics from entering the power supply and disturbing other sensitive equipment in the distribution system. These filters are also used with many electrotechnology applications such as microwave heating and radio-frequency drying equipment. In some cases, the filters are used to comply with Federal Communication Commission regulations regarding the transmission of signals that interfere with communication channels.

Strategies for VFDs. The following actions can improve power quality in facilities using VFDs:

- Install input-line reactors (typically, 3% impedance) to reduce impacts from transients and mitigate harmonic currents
- Keep the distance from the drive to the motor to within 50 feet; if a longer distance is required, consider using output filters or load reactors to reduce potential overvoltage transients.
- Separate input power, output power, and communication cables by at least 12 inches to minimize the EMI to control circuits. Install input, output power, and

controls in separate metal conduit or use metal shielding between them if they are in adjacent cable trays.

- If there are trips caused by momentary high or low voltage, check with the manufacturer to determine if the trip settings bandwidth can be increased.
- Consider automatic restart (flying restart) to mitigate trips caused by overvoltage or undervoltage, if an automatic restart is appropriate for the end-use and can be done safely.

Uninterruptible Power Supply Systems. Uninterruptible power supply (UPS) systems should be considered for plants in which voltage sags or power interruptions can be particularly costly. Although UPS systems can be configured in many ways, they can be grouped into two principal types: static and dynamic.

Static systems rely on batteries to provide power when the incoming power either sags or stops completely. Dynamic systems rely on the inertia of a rotating mass—usually a flywheel—to supply rotating force to a generator long enough for an engine to start and take over as the prime mover.

On-Site Power Generation. On-site power generation is used for cogeneration and to provide backup, standby, and emergency power. On-site power systems consist of generators powered by reciprocating engines or gas turbines; or biomass or gas-fired boilers that produce superheated steam for use in back-pressure steam turbines or extraction/condensing turbines. These units are fueled by natural gas or stored fuels such as propane, diesel fuel, biomass, or oil. Fuel cells are a promising alternative technology. Key considerations in selecting on-site generation systems are maximum electric load, waste-heat recovery opportunities, number of times the system is expected to operate, time required for the system to operate, and speed of startup.

Current and frequency problems are not common in large utility systems, but they can occur in plants that self-generate. With on-site generation, the electric power generator is sized to reflect individual end-use loads. As large loads are added or dropped, the effect on the generator can be significant. In such cases, variations in frequency and current can be the result.

Efficiency Opportunity No. 7: Using the Service Center Evaluation Guide

Most users want to be sure that they are paying for a high-quality repair, but what does that mean? It certainly

means more than ending up with a neat, clean motor. Errors and careless workmanship can reduce the efficiency and shorten the life of the repaired motor. This evaluation guide can assist industrial plants in evaluating a motor service center’s capabilities, practices, and quality in regard to repairing low-voltage induction motors.

Customers of motor repair service centers need to be knowledgeable about the service they are purchasing. It is important to specify the expected scope and quality of work. However, clear instruction alone cannot ensure quality work if the service center is not capable of it.

There are several ways to evaluate a service center. Having a repaired motor tested at a lab certified by the National Volunteer Laboratory Accreditation Program can help to determine the motor’s efficiency per IEEE 112-2004 Method B, and to detect certain types of repair errors or shortcuts. However, this is usually impractical because of the time and expense involved, and it may not reveal whether a lower-than-nameplate efficiency resulted from the recent repair or predated it. This also cannot reveal whether one repaired motor is typical of all those from the same service center.

A variety of predictive maintenance tests can be done to rule out certain flaws or rewinding errors that could reduce a rebuilt motor’s service life rather than lower its efficiency. It can also be helpful to inspect the service center and interview its staff.

Obtaining Information

The following elements can indicate a service center’s ability to perform high-quality motor repair work.

Primary Market Niche. An important first step is to assess whether the service center does a significant amount of repair work on motors of the type and size that your plant is likely to submit. For example, a plant that uses small induction motors for the most part will want to avoid a service center whose “bread and butter” is locomotive motor-generator sets. Work done outside a service center’s primary market niche may be unacceptable in terms of quality and price. Plants that use a wide range of motor types can benefit from selecting two or more appropriate, qualified repair service centers as needed.

Tools and Facilities. Next, an informal inventory of the facility and its capabilities and tools can be very helpful. It is difficult to conduct thorough diagnostics and verify repairs without having equipment like surge testers and a

well-regulated power supply. The service center must be able to handle the largest motors you expect to submit. For example, the winding heads must be able to duplicate the original winding patterns. Form-wound coils are often subcontracted, but these are not normally used in low-voltage motors.

Repair Materials. It is helpful to check on whether the center houses a variety of materials needed for motor repairs such as electrical insulation materials. These include slot liners, wire sleeves, special paper separators for coil groups, and material for tying and restraining end turns. Most service centers stock only Class F or Class H insulating materials, which often exceed original insulation heat ratings. This makes things simpler for the shop, and it adds a slight thermal margin for motors that were originally insulated at a lower thermal class.

The repair should duplicate the original coils—the same dimensions, number of effective turns, and cross-sectional area—unless proven better alternatives are agreed upon. To do this, service centers should either carry a broad inventory of wires in various sizes or describe how they obtain the sizes needed quickly to meet your turnaround requirements.

Staff. It can be helpful to inquire about the repair service center’s staff. The center’s staff should be stable, knowledgeable, experienced, and well-trained. A low turnover rate can indicate a high degree of employee satisfaction and a willingness on the part of management to invest in training and education.

Record Keeping. Motor management is like health care, in that a record of past problems and remedies can be invaluable for diagnosing or preventing new problems and resolving warranty issues. An elaborate computer system may be impressive, but many service centers keep good records on job cards. These can be thorough and retained for many years. So it is important to inquire about the repair center’s record-keeping system.

Cleanliness. Almost intuitively, we associate cleanliness with good quality management. This is more than a matter of aesthetics because most of the materials and supplies used in a motor service center need to be protected from contamination. Observe the cleanliness of the center. Tools and test equipment should be organized, so they can be retrieved and used easily. To maintain their calibration, gauges and testing equipment should be put away or protected from damage when they are not in use. Places where bearings and lubricants are stored or installed must

be clean because even a small particle can cause premature bearing failure.

Standard Operating Procedures. Finally, it is important for the center to maintain high levels of quality. Ideally, this includes a formal quality management system involving third-party inspections and certification. These are still rare, but they may become more commonplace as a result of EASA’s promotion of the EASA-Q quality management system, Advanced Energy’s Proven Excellence certification program, adherence to Green Motors Practices in the Pacific Northwest, and increasing awareness of ISO 9000 quality management standards. Service center managers should be able to point to documents that provide standards, operating procedures, and important records. Examples are bearing-fit standards, testing procedures, forms for record keeping, and calibration records.

Determining satisfactory adherence to high-quality workmanship standards can be time-consuming. Two methods are available for evaluation: interviews and inspections. Both should be used to an appropriate degree. To ensure a comprehensive evaluation, a “Motor Repair Service Center Checklist” is provided in Appendix D of this sourcebook. It can be completed during the interview and annotated as necessary during a walk-through inspection. The checklist may not be necessary for infrequent customers of rewind services, but it does indicate the equipment and practices that are important for high-quality repairs.

Conducting the Evaluation

The first step is to make an appointment with the service center; plan to reserve at least half a day. Advise the service center manager that this is part of a structured evaluation and that the manager might be asked to produce evidence of such things as employee training or equipment calibration practices.

Finally, be well informed. It is important to be familiar with motor construction, repair methods, and related issues. Read the ITP’s (now AMO’s) *Motor Repair Tech Brief*,⁶¹ and if possible, more detailed sources such as *ANSI/EASA AR100-2010: Recommended Practice for the Repair of Rotating Electrical Apparatus*,⁶² and *The Effect of Repair/Rewinding on Motor Efficiency: EASA/AEMT Rewind Study and Good Practice Guide*.⁶³

⁶¹ www.eere.energy.gov/manufacturing/tech_deployment/pdfs/tech_brief_motors.pdf

⁶² www.easa.com/techarticles/AR100-2010

⁶³ www.easa.com/sites/default/files/rwstdy1203.pdf

SECTION 3: MOTOR SYSTEM ECONOMICS

Overview

Industrial facility managers often have to convince corporate management that energy efficiency improvements are worth the investment, which can be more of a challenge than the engineering behind the improvement. An effective way to begin the project proposal process is to analyze the economic impacts of the efficiency improvement. This can include determination of the simple payback, net present value, or rate-of-return on investment (ROI) for an energy efficiency measure or package of measures. It is also useful to supply metrics that show compliance with corporate energy management goals. These can include the expected annual kilowatt-hours (kWh) or million British thermal units (MMBtu) saved, factory energy use reductions (%), and greenhouse gas emission reductions (tonnes/year).

The economic approach also enables facility managers to relate energy efficiency improvements to non-energy related investment opportunities. And it allows financing department staff members to help prepare the kind of proposal that will persuade corporate officers of the monetary benefits of system upgrades.

This section contains some recommendations for proposing energy efficiency improvement projects to management. The first step is to better understand the point of view and the priorities of corporate officers.

Understanding Corporate Priorities

Corporate officers are held accountable to a chief executive, a board of directors, and an owner or shareholders if the company is publicly held. The job of these officers is to create and grow the equity value of the firm. The corporation's industrial facilities do so by generating revenue that exceeds the cost of owning and operating the facility. Plant equipment—including system components—are assets that must generate an economic return.

The *rate of return on assets* is the annual earnings attributable to the sale of goods produced by those assets, divided by the value of the assets. This rate of return is a key measure by which corporate decision-makers are held accountable. Financial officers look for investments that will generate a favorable return on assets. When faced with multiple investment opportunities, these officers favor the options that lead to both the largest and the quickest returns.

This approach to making business decisions can impose several priorities on the facility manager. These include ensuring reliability in production, avoiding unwanted surprises by sticking with familiar technologies and practices, and contributing to cost control *today*, sometimes by cutting corners in equipment maintenance and upkeep. As a result, efficiency is often viewed as a luxury rather than a necessity.

Fortunately, the story does not end here. This section describes the ways that industrial efficiency can save money and contribute to corporate goals while effectively reducing energy consumption and cutting pollutant emissions caused by combustion processes. This is information that the facility manager can use to make a more compelling case for an industrial efficiency project.

Measuring the Economic Impact of Efficiency Improvements

Motor system improvement projects can move to the top of the list of corporate priorities if the proposals reflect distinct corporate needs. There are usually many opportunities to improve the motor systems of an industrial plant. Once the facility manager identifies one or more much needed projects, the next task is to prepare a proposal that reflects corporate priorities in financial language.

The first step is to determine the total equipment and installation costs; maintenance costs, and annual energy savings due to implementation of an energy efficiency measure. A life cycle cost (LCC) analysis provides an effective framework for showing the cumulative benefits over the measure's life. LCC analyses incorporate inflation and discount rates to express the expenses and benefits over the life of an investment in present value dollars. The result—expressed as a net gain or loss—can be compared with other investment options or with the expected outcome or baseline due to not making the investment.

This kind of analysis often shows that electricity costs represent as much as 96% of the total motor system LCC, the initial capital outlay only makes up 3% of the total, and maintenance accounts for a mere 1%. Clearly, any measure that reduces electricity consumption without reducing reliability and productivity will have a positive financial impact on the company.

Presenting the Finances of Efficiency

There are many ways to measure the financial impact of investments in efficiency. Some analysis methods are more complex than others, and a proposal may be based on several of them. The choice is up to the presenter and should take the audience into account.

A simple (and widely used) measure of project economics is the *payback period*. This is the period of time required for a project to “break even” or for the net benefits of an investment to accrue to the point where they equal the cost of the initial outlay. For a project that returns benefits in consistent, annual increments, the *simple payback* equals the initial investment divided by the annual benefit. It does not take into account the time value of money; in other words, it makes no distinction between a dollar earned today and one earned in the uncertain future. Still, the simple payback period is easy to use and understand, and many companies use it as the basis for a quick “go/no-go” decision.

There are five important factors to remember when calculating a simple payback:

- It is an approximation, not an exact economic analysis.
- All benefits are measured without considering their timing.
- Economic consequences beyond the simple payback period are ignored. A project with a 2-year simple payback period may have a 3-, 10-, or 20-year useful operating life. Obviously, the 20-year project provides the greatest overall economic benefits, but future benefits are not captured in a simple payback analysis.
- Because of the two previous factors, payback calculations do not always indicate the best choice among several project options.
- The payback calculation does not take into account the time value of money or tax consequences.

More sophisticated analyses take into account factors such as discount rates, tax impacts, and the cost of capital. One approach involves calculating the *net present value* of a project, which is defined as follows:

$$\text{Net present value} = \text{present worth of benefits} - \text{present worth of costs}$$

Another commonly used calculation for determining economic feasibility of a project is the *internal rate of return*, which is the discount rate that equates future net benefits (cash) to an initial investment outlay. This discount rate can be compared to the interest rate at which a corporation borrows capital.

Many companies set a threshold (or hurdle) rate for projects, which is the maximum simple payback or minimum required internal rate of return for a project to be considered viable. Future benefits are discounted at the threshold rate, and the net present worth of the project must be positive in order for the project to be a “go.”

Relating Efficiency to Corporate Priorities

Future cost savings should be a strong incentive to improve the efficiency of a plant’s motor systems. But it might not be enough. The facility manager can strengthen the case for making improvements by relating a favorable LCC to determine corporate needs. Staff in finance departments can determine which of the following suggestions for interpreting the benefits of electricity cost savings would work best in a specific company.

A New Source of Permanent Capital

Lower electricity costs—a direct benefit of efficiency—can be regarded as a new source of capital for the company. The investment that makes greater efficiency possible will yield annual savings each year over the economic life of the improved system. Regardless of how the efficiency investment is financed—through borrowing, retained earnings, or third-party financing—the net annual cost savings will be a permanent source of revenue as long as the efficiency savings continue.

Direct Measurement

Assumptions:

3-phase motor
 0.85 power factor (nameplate)
 0.05 \$/kWh unit electricity cost
 Annual hours of operations = 8,760 hours
 (3-shift, continuous operation)

Case 1. Using a Wattmeter

Annual electricity costs =
 Wattmeter reading (using a 3-phase setting) ×
 (annual hours of operation) ×
 (electricity cost in \$/kWh)

Example:

Wattmeter reading = 77.88 kW

Annual electricity costs =
 (77.88 kW) × (8,760 hours) × (\$0.05/kWh) = \$34,111

Case II. Using a Voltmeter and an Ammeter Separately

Annual electricity costs =
 [(load amps) × (volts) × (1.732) × (power factor)]/1000 × (annual hours of operation) ×
 (electricity cost in \$/kWh)

Example:

Average load amp measurement across all phases = 115A
 Measured voltage = 460 V

Annual electricity costs =
 [(115 A) × (460 V) × (1.732) × (0.85)]/1000 ×
 (8,760 hours) × (\$0.05/kWh) = \$34,111

Added Shareholder Value

Publicly held corporations usually take advantage of opportunities to enhance shareholder value, and motor system efficiency can be an effective way to capture this value. Shareholder value is the product of two variables: annual earnings and the price-to-earnings (P/E) ratio. The P/E ratio describes the corporation’s stock value as the current stock price divided by the most recent annual earnings per share. To take advantage of this measure, the

Simple Calculation

Annual energy costs =
 (motor full-load brake horsepower) ×
 (0.746 kW/hp) × (1/motor efficiency) ×
 (annual hours of operation) ×
 (electricity cost in \$/kWh) × load factor

Assumptions:

Cost of electricity = \$0.05/kWh
 Load factor = 65%
 Motor efficiency = 95%

Example:

Motor full-load hp = 100 hp
 Annual hours of operation = 8,760 hours
 (3-shift, continuous operation)

Annual electricity costs =
 (100 hp) × (0.746 kW/hp) × (1/0.95) × (8,760 hours) ×
 (\$0.05/kWh) × .65 = \$22,356

efficiency project proposal should first identify the annual savings (or rather, addition to earnings) that the proposal will generate. Multiplying that earnings increment by the P/E ratio yields the total new shareholder value attributable to the efficiency project.

Greater Comfort and Safety

Optimizing motor systems requires continual monitoring and maintenance, and these benefit workers in terms of enhanced safety and comfort. Routine system monitoring usually uncovers operational abnormalities before they present a danger to plant personnel. Eliminating or controlling these dangers reduces the threats to life, health, and property in the workplace.

Improved Reliability and Capacity Utilization

Another benefit of greater efficiency is the more productive use of assets. Efforts to achieve and maintain energy efficiency will also contribute to operating efficiency. By ensuring the integrity of system assets, the facility manager can promise more reliable plant operations. From a corporate perspective, this also means a greater rate of return on a plant’s assets.

Better Bottom Line

Each dollar saved on electricity goes directly to the bottom line. For a corporation with a 10% profit margin, each dollar of electricity savings is equivalent to 10 times that amount in sales revenue.

A Call to Action

A proposal for implementing an efficiency improvement can be attractive to corporate decision makers if it contains the following:

- Specific opportunities for improving efficiency
- The LCC results associated with each proposed efficiency project
- Identified project(s) that have the greatest net benefits
- Connections to current corporate financial priorities—added shareholder value, reduction of environmental compliance costs, and improved capacity utilization
- Ways in which the benefits of each project respond to current corporate needs. This can include compliance with energy use or greenhouse gas emission reduction goals.

Life Cycle Costs

Motor systems are critical to the operation of almost every industrial facility and account for about 60%–70% of all the electricity used in an average plant. In spite of this, many facilities have no idea how much motor system operation costs on an annual basis, or how much money they could save by improving the performance of their motor systems.

LCC analysis is important when managing electric motor systems. Performing an LCC analysis on a system refers to an economic analysis that takes into account all of a project’s costs, including:

- Search and selection costs for an engineering implementation firm
- Initial capital cost, including installation and the cost of borrowing money
- Maintenance costs
- Supply and consumable costs
- Energy costs over the economic life of the equipment
- Depreciation and tax impacts

- Other annual or periodic costs
- Scrap value or cost of disposal at the end of the project’s or equipment’s life
- Effects on production such as product quality, reduced reject rates, and downtime.

LCC analyses should include the “time value of money.” These analyses are typically performed to compare one alternative with another, or to see if a project should be undertaken, based on a company’s minimum threshold for return on the investment. A helpful tool in determining motor LCCs is the U.S. Department of Energy’s (DOE’s) MotorMaster+ software program. Further information on this tool is available in Section 2, “Efficiency Opportunity No. 2: Establishing a Motor Management Program.”

Calculating Electricity Costs

Electricity costs can be determined by using motor nameplate data or directly measuring current or power usage. With any of these methods, the data must represent actual system operating conditions to be useful. In systems with widely varying operating conditions, collecting data only once will not provide a true indication of the amount of energy that a motor system consumes.

Nameplate Data Method. A quick way to estimate energy costs is to complete a motor survey and assume the motor operates at the full-load efficiency displayed on the motor nameplate. Motors without such an efficiency value are almost certainly old, standard efficiency motors. Additional necessary data includes annual hours of operation (hours per year), unit cost of electricity (\$/kWh), and average *load factor*, which refers to the average percentage of full-load electric power at which the motor operates.

Motor system economic analyses are driven largely by the amount of time and the percentage of its full capacity at which the motor system operates. To account for the fact that a motor usually does not operate at its rated full load all the time, its average load factor can be estimated. Annual electricity costs can be calculated by inserting this information into the simple calculation methodology shown in the “Simple Calculation”

Direct Measurement Method. A more accurate way to determine electricity consumption is to take electrical measurements. The direct measurement method requires reading power [kilowatt (kW)] with a wattmeter or reading amps (A) and volts (V) and calculating kW using the nameplate power factor.

Wattmeters require two simultaneous inputs—voltage and current; many motor installations do not provide convenient access to both. To calculate electricity consumption, the measured kW value is multiplied by hours of operation and electricity costs, as shown in Case I in the “Direct Measurement” sidebar. This calculation is for a motor with a constant load, that is, one that does not vary over time.

If a wattmeter is not available or if it is not practical to use one, then current and voltage can be measured separately. Note that the average current and voltage should be determined from readings taken on each phase. If there is a possibility the motor load is below 55% of the motor’s rated capacity, then calculations using direct measurement of current and voltage will not provide useful results, because of the nonlinearity of motor amperage draw with load at low motor loadings.

A clamp-on type ammeter is used to measure current on each of the three power cables running to the motor; most industrial motors are three-phase. It can be convenient to take these readings at the motor controller; however, the junction box on the motor itself is sometimes more accessible. Line voltage is usually measured at the motor controller, preferably at the same time that the current reading is taken. In some facilities, line voltage drops with increases in power usage. See the calculation for a motor with a constant load shown in Case II in the sidebar “Direct Measurement.”

Direct measurements of motor current, however, are not always practical. Taking hot measurements (at high power levels) of motor current poses safety risks for workers; these measurements might not be feasible in an industrial environment where power connections are exposed to moisture or contaminants.

Energy and Demand Charges—Understanding Your Utility Bill

The calculations shown earlier use electricity rates stated in terms of \$/kWh. However, electric utilities use more complicated rate structures to bill their industrial customers. These typically include both energy (\$/kWh) and demand charges (\$/kW-month). Different rates may be in effect depending on the level of consumption and the time of year. Demand charges are based on the peak demand for a given month or season and can have significant impacts on the electricity costs of industrial customers. Other components of industrial electricity bills, such as power factor penalties, can be affected by electric motor systems.

For example, the use of lightly loaded induction motors can adversely affect the power factor of a plant and lead to higher bills. For more information on interpreting utility billing statements and on the benefits of correcting low-power factor, see the “Understand Your Utility Bill” and Power Factor Correction chapters in the DOE Advanced Manufacturing Office’s (AMO’s) publication *Continuous Energy Improvement in Motor Driven Systems*.⁶⁴

When the economic impacts of efficiency measures are calculated, the marginal cost of the electricity must be considered. This takes into account energy and demand charges, seasonal rates, power factor penalties, and different rates for different levels of consumption. Electric utilities can answer questions about their electrical tariffs.

Maintenance Considerations

There are two principal types of maintenance: preventive (scheduled) and predictive maintenance (PPM) (condition assessment) and repair. A PPM schedule can improve system reliability, reduce the risk of unplanned downtime, and help plants avoid expensive failures. Repair involves both the parts and labor required to troubleshoot and fix equipment that is not performing properly or has broken. In general, PPM is less costly than breakdown maintenance, i.e., run-to-failure. A well-designed PPM schedule minimizes the need for repairs by detecting and resolving problems before they develop into more serious issues.

Similarly, effective design and equipment specification practices can help to minimize operating costs. Taking LCCs into account during the initial system design phase or when planning system upgrades and modifications can both reduce operating costs and improve system reliability.

Summary

A highly efficient motor system is not just one with a premium efficiency motor. Rather, overall system efficiency is the key to maximizing cost savings. Many motor system users tend to be more concerned with initial costs and obtaining the lowest bids for components than with system efficiency. For optimum motor system economics, motor system users should use an LCC analysis to select the best equipment, and then carefully operate and maintain the equipment for peak performance.

⁶⁴ www1.eere.energy.gov/manufacturing/tech_assistance/motors.html

SECTION 4: WHERE TO FIND HELP

This section lists resources that can help end users increase the cost-effectiveness and performance of their motor and drive systems. It has four main subsections: Advanced Manufacturing Office (AMO) Overview, Federal Energy Management Program (FEMP), Directory of Contacts, and Other Resources and Tools.

Advanced Manufacturing Office (AMO) Overview

According to the U.S. Energy Information Administration (EIA 2012), Industrial manufacturing consumes approximately 33% of all energy used in the United States. The U.S. Department of Energy (DOE) AMO has programs to assist industry in achieving significant energy and process efficiencies. AMO develops and delivers advanced energy efficiency, renewable energy, and pollution prevention technologies and practices for industrial applications. Through industry partnerships, AMO works with the nation's most energy- and resource-intensive industries to develop advanced processes and technologies to achieve these goals.

The advancement of energy- and process-efficient technologies is complemented by AMO energy management resources for immediate savings results. AMO provides technical assistance for the purposes of base-year energy intensity determinations and preliminary analyses to identify and realize manufacturers' best energy efficiency and pollution prevention options from a system and life cycle cost perspective. AMO sponsors training and information that helps identify efficiency opportunities for industry that yield significant energy and cost savings, waste reduction, pollution prevention, and enhanced environmental performance. Small- to medium-sized manufacturers can qualify for no-cost plant energy assessments from the university-based Industrial Assessment Centers. Another resource is the Department of Energy's Better Buildings, Better Plants program at: <http://www1.eere.energy.gov/manufacturing/index.html>.

Emerging Technologies

Emerging technologies result from research and development and are ready for full-scale demonstration in real-use applications. AMO recognizes that companies may be reluctant to invest capital in these new technologies, even though they can provide significant energy and process improvements.

By sharing implementation and providing third-party validation and verification of performance data, the energy, economic, and environmental benefits can be assessed to accelerate new technology to acceptance.

Systems Energy Assessment Support

AMO encourages manufacturers to adopt a comprehensive approach to energy use that includes assessing industrial systems and evaluating potential improvement opportunities. Efficiency gains in fan, compressed air, motor, process heating, pumping, and steam systems can be significant and usually yield immediate energy and cost savings. AMO offers software tools and resources in a variety of system areas to help industry become more energy and process efficient, reduce waste, and improve environmental performance.

Technical Resources

AMO offers a variety of resources to help industry achieve increased energy and process efficiency, improved productivity, and greater competitiveness.

AMO Website. The AMO website offers a wide array of information, products, and resources to assist manufacturers that are interested in increasing the efficiency of their industrial operations. Users can gain access to Web pages for the eight Industries of the Future, learn about upcoming events and solicitations, and much more through this site. Visit the AMO website at: manufacturing.energy.gov.

AMO Software Tools

AMO and its partners have developed several software tools for systems improvements to help you make decisions about implementing efficient practices in your manufacturing facilities.

- **AirMaster+**⁶⁵ provides comprehensive information on assessing compressed air systems, including modeling, existing and future system upgrades, and evaluating savings and effectiveness of energy efficiency measures.
- The **NO_x and Energy Assessment Tool (NxEAT)**⁶⁶ helps plants in the petroleum refining and chemical industries to assess and analyze oxides of nitrogen (NO_x) emissions and how the application of energy efficiency improvements can reduce NO_x. Use this tool to perform “what-if” analyses for systems such as fired heaters, boilers, gas turbines, and reciprocating engines.
- The **Steam System Assessment Tool (SSAT)**⁶⁷ allows users to assess potential savings from individualized steam-system improvements. Users input data about their plant’s conditions, and the SSAT generates results detailing the energy, cost, and emissions savings that various improvements could achieve.
- **Steam System Modeler and Calculators** is a tool that allows users to create up to a 3-pressure-header basic model of your current steam system. The model can then be modified to indicate how each component and adjustment impacts the overall efficiency and stability of the system.
- The **Steam System Scoping Tool**⁶⁸ is designed to help steam system energy managers and operations personnel for large industrial plants. This spreadsheet program profiles and grades steam systems operations and management. This tool will help users evaluate their steam system operations against identified best practices.
- **3E Plus**⁶⁹, an insulation thickness optimization software tool, allows users to easily determine whether steam, hot water, or chilled water systems offer energy savings through adding insulation to piping or heated surfaces. The program calculates the most economical thickness of industrial insulation for a variety of

operating conditions. Users can make calculations using the built-in thermal performance relationships of generic insulation materials or supply conductivity data for other materials.

- The **Process Heating Assessment and Survey Tool (PHAST)**⁷⁰ provides an introduction to process heating methods and tools to improve thermal efficiency of heating equipment. Use the tool to survey process heating equipment that uses fuel, steam, or electricity, and identify the most energy-intensive equipment. Tool users can also can perform an energy (heat) balance on selected equipment (furnaces) to identify and reduce nonproductive energy use. Use PHAST to compare performance of the furnace under various operating conditions and test “what-if” scenarios.
- The **Pumping System Assessment Tool (PSAT)**⁷¹ helps industrial users assess the efficiency of pumping system operations. PSAT uses achievable pump performance data from Hydraulic Institute standards and motor performance data from the MotorMaster+ database to calculate potential energy and associated cost savings.
- The **Fan System Assessment Tool (FSAT)**⁷² helps industrial users assess the efficiency of fan system operations. FSAT uses achievable fan performance data from the Air Movement and Control Association standards and motor performance data from the MotorMaster+ database to calculate potential energy and associated cost savings.

AMO Motor and Drive System Tools

Software: MotorMaster+ and MotorMaster International

MotorMaster+⁷³ is an energy-efficient motor selection and management software tool, which includes a catalog of more than 17,000 AC motors. The software also features motor inventory management tools, maintenance log tracking, efficiency analysis, savings evaluation, energy accounting, and environmental reporting capabilities.

⁶⁵ www.eere.energy.gov/manufacturing/tech_deployment/software_airmaster.html

⁶⁶ www.eere.energy.gov/manufacturing/tech_deployment/software_nxeat.html

⁶⁷ www.eere.energy.gov/manufacturing/tech_deployment/software_ssat.html

⁶⁸ www.eere.energy.gov/manufacturing/tech_deployment/software_ssat.html

⁶⁹ http://apps.eere.energy.gov/buildings/tools_directory/software.cfm?ID=445/pagename=alpha_list_sub

⁷⁰ www.eere.energy.gov/manufacturing/tech_deployment/software_phast.html

⁷¹ www.eere.energy.gov/manufacturing/tech_deployment/software_psat.html

⁷² www.eere.energy.gov/manufacturing/tech_deployment/software_fsat.html

⁷³ www.eere.energy.gov/manufacturing/tech_deployment/software_motormaster.html

MotorMaster International⁷⁴ includes many of the capabilities and features of MotorMaster+; however, users can evaluate repair/replacement options on a broader range of motors, including those tested under the Institute of Electrical and Electronic Engineers standard, and metric motors tested using International Electrical Commission methodology. With this tool, users can conduct analyses in different currencies; calculate efficiency benefits for utility rate schedules with demand charges; edit and modify motor rewind efficiency loss defaults; and determine the “best available” motors. The tool has been modified to operate in English, Spanish, French, German, Traditional Chinese, and Simplified Chinese.

AMO Motor-Related Technical Publications

To increase industry awareness of several fundamental improvement opportunities, AMO has developed several motor tip sheets through its Best Practices program. These tip sheets provide concise descriptions of common improvement opportunities. For a list of tip sheets, see Appendix B in this sourcebook. Compressed air, pumping, and fan system tip sheets are also available at the AMO website.

AMO has also developed technical publications that provide an increased level of detail and guidance in identifying and implementing performance improvement opportunities. For additional information on premium efficiency motor savings opportunities and motor/adjustable-speed drive interactions, see the *Premium Efficiency Motor Selection and Application Guide*.⁷⁵ For information on energy management actions and savings opportunities relating to motors, adjustable speed drives, and driven equipment, see *Continuous Energy Improvement in Motor Driven Systems*.⁷⁶ In addition, fact sheets, market assessments, and repair documents concerning “Motor Systems” can be found on the AMO website.⁷⁷

AMO Energy Management Program Support

The AMO Energy Resources Center or ECenter provides a “how to” guide on creating, strengthening, building, launching, and maintaining an energy management team and provides tools that assist organizations to track energy

flows within their plant and to monitor the progress of their energy efficiency programs. The ECenter is located at: <https://ecenter.ee.doe.gov/Pages/default.aspx> Brief descriptions of several ECenter tools follow.

The **Plant Energy Profiler**, or PEP, is an online software tool provided by AMO to help industrial plant managers identify how energy is being purchased and consumed at their plant. PEP is designed so that the users can complete a plant profile in about an hour and obtain a report that shows the details of energy purchases, how energy is consumed, potential cost and energy savings, and a list of next steps that can be followed to save energy. The PEP tool can be accessed at: <https://ecenter.ee.doe.gov/EM/tools/Pages/ePEP.aspx>

eGuide Lite is for organizations that are new to energy management. eGuide assists organizations to understand what kinds of energy they use, how they use it, and how much of it they use while also increasing their awareness of options to reduce energy consumption. The eGuide Lite walks organizations through the steps of implementing basic energy management. Organizations that use this module can identify, plan, and initiate sustainable energy improvements on an ongoing basis. Organizations already familiar with energy management and related systems may instead begin with the *eGuide for ISO 50001*. eGuide addresses such topics as:

- Securing top management commitment to energy savings
- Appointing an energy manager and energy champions
- Establishing an energy team
- Collecting energy use data
- Defining a normalized facility energy use baseline or benchmark
- Establishing an energy tracking system
- Conducting assessments to identify and prioritize energy savings opportunities
- Developing plans to address staff training needs
- Defining purchasing specifications
- Reviewing and reporting progress to upper management
- Integrating energy management best practices into the corporate culture.

⁷⁴ www.eere.energy.gov/manufacturing/tech_deployment/software_motormaster_intl.html

⁷⁵ www1.eere.energy.gov/manufacturing/tech_assistance/motors.html

⁷⁶ www1.eere.energy.gov/manufacturing/tech_assistance/motors.html

⁷⁷ www.eere.energy.gov/manufacturing/tech_deployment/motors.html

The **Energy Performance Indicator** Tool (EnPI) is a tool designed to help industrial firms obtain information on the effect of their energy efficiency efforts. At its core, it is an energy performance tracking tool. It employs regression analysis to help organizations calculate energy performance indicators by normalizing for things like weather, production, and other variables.

AMO has also established several programs that enable partnering manufacturers to obtain technical support and gain national recognition for their energy management efforts. Under the **Better Buildings, Better Plants** program, partners demonstrate their commitment to saving energy by signing a voluntary pledge to reduce their corporate energy intensity (energy use per unit of product) by 25% over ten years.

Superior Energy Performance (SEP) is a certification program that provides facilities with guidance towards achieving continual improvement in energy efficiency while maintaining competitiveness. A basic element of SEP is implementation of the ISO 50001 energy management standard with additional requirements to achieve and document energy performance improvement. Certification requires third party verification of conformance to ISO 50001 and energy performance improvement. For further information on SEP, please visit <http://www.superiorenergyperformance.net/>. For more details on energy management, please visit www.eere.energy.gov/energymanagement.

AMO Case Studies and Performance Spotlights

Motor system case studies and performance spotlights describe successful energy and process improvement projects that are boosting productivity and saving energy at U.S. industrial plants. Many case studies examine the bottom-line benefits that successful applications of energy-efficient practices and technologies can yield. See motor system-specific case studies and performance spotlights on the AMO website.⁷⁸

News

The *Advanced Manufacturing Office* news update is a periodic email that spotlights program activities; new AMO products, training and events, Web updates, and solicitations. Subscribe at manufacturing.energy.gov. AMO also offers periodic on-line training.

⁷⁸ www.eere.energy.gov/manufacturing/tech_deployment/motors.html

Federal Energy Management Program (FEMP)

DOE's FEMP new motor purchase and motor repair guidelines for federal facilities are summarized on its website.⁷⁹

Section 313 of the Energy Independence and Security Act of 2007 raised federal minimum efficiency standards for general-purpose, single-speed, polyphase induction motors of 1 to 500 horsepower. This new standard took effect in December 2010. The new minimum efficiency levels match FEMP's performance requirement for these motors.

Directory of Contacts

Information on improving the performance of industrial energy systems is available from many resources.

U.S. Department of Energy Advanced Manufacturing Office (AMO)

Room 5F-065, MS EE-2F
1000 Independence Ave., SW
Washington, DC 20585
202-586-9488
manufacturing.energy.gov

For an AMO overview, see page 76.

American National Standards Institute (ANSI)

25 West 43rd Street, 4th Floor
New York, New York 10036
212-642-4900; Fax: 212-398-0023
www.ansi.org

To download standards: www.webstore.ansi.org

ANSI is a private, nonprofit organization that administers and coordinates the U.S. voluntary standardization and conformity assessment system. The institute's mission is to enhance both the global competitiveness of U.S. business and the U.S. quality of life by promoting and facilitating voluntary consensus standards and conformity assessment systems, and safeguarding their integrity.

⁷⁹ www.eere.energy.gov/femp/technologies/eep_emotors.html

WHERE TO FIND HELP

American Society of Mechanical Engineers (ASME)

ASME has developed a set of standards that support the energy management planning process by providing guidance and protocols for conducting system-level energy efficiency assessments. While use of these standards is not required for ISO or SEP certification, their use helps to ensure that energy efficiency opportunities are properly identified, analyzed, and implemented in a systems-focused and life-cycle cost prioritized fashion. The ASME standards include those in the following list. (Visit www.asme.org for more details.)

Energy Assessment for:

- ASME EA-1-2009 — Process Heating Systems
- ASME EA-2-2009 — Pumping Systems
- ASME EA-3-2009 — Steam Systems
- ASME EA-4-2010 — Compressed Air Systems

Air Movement and Control Association International

30 West University Drive
Arlington Heights, IL 60004
847-394-0150
www.amca.org

Bonneville Power Administration

P.O. Box 3621
Portland, OR 97208-3621
503-230-3000
www.bpa.gov

BPA has assembled a database of 400 innovative, emerging, and underutilized electrical energy efficiency technologies, including many in the industrial sector. The database contains information on the commercial availability of each technology and whether or not quantifiable and reliable energy savings are obtainable. The database also describes how well each technology works and in what application niches; plus addresses first cost, standard practice and competing technologies, non-energy benefits, user drawbacks, savings dependencies, measure life, cost-effectiveness, and operation and maintenance requirements. The database may be viewed at www.E3TNW.org. BPA also offers an Industrial Audit Guide and an ASD Calculator tool. The guide and tool may be obtained at <http://www.bpa.gov/energy/n/industrial/audit/>

Consortium for Energy Efficiency, Inc. (CEE)

98 North Washington Street, Suite 101
Boston, MA 02114-1918
617-589-3949; Fax: 617-589-3948
www.cee1.org

CEE, a nonprofit public benefits corporation, develops national initiatives to promote the manufacturing and purchase of energy-efficient products and services. Efficiency programs across the United States and Canada use CEE national initiatives to increase the effectiveness of their local efforts. Founded in 1992, CEE is the only national organization for all ratepayer-funded efficiency program administrators.

CEE members include administrators of energy-efficiency programs and their key public stakeholders. This includes utilities, statewide and regional energy-efficiency administrators, environmental groups, research organizations, and state energy offices.

Copper Development Association (CDA)

260 Madison Avenue
New York, NY 10016
212-251-7200; Fax: 212-251-7234
www.copper.org

CDA is a U.S.-based, not-for-profit association of the global copper industry, influencing the use of copper and copper alloys through research, development, education, promotion, technical, and end-use support.

Electric Power Research Institute (EPRI)

3420 Hillview Avenue
Palo Alto, CA 94304
800-313-3774 or 650-855-2121
www.epri.com

EPRI is composed mainly of electric utility companies. EPRI's charter is to discover, develop, and deliver high value technological advances through networking and partnership with the electricity industry.

WHERE TO FIND HELP

Electrical Apparatus Service Association, Inc. (EASA)

1331 Baur Boulevard
St. Louis, MO 63132
314-993-2220; Fax: 314-993-1269

EASA is an international trade organization of more than 1,900 electromechanical sales and service firms in 59 countries. Through its engineering and educational programs, EASA provides members with a means of keeping up-to-date on materials, equipment, and state-of-the-art technology.

Hydraulic Institute

6 Campus Drive, First Floor North
Parsippany, NJ 07054-4406
973-267-9700
www.pumps.org

Institute of Electrical and Electronics Engineers (IEEE)

3 Park Avenue, 17th Floor
New York, NY 10016
800-678-4333 (USA and Canada) or
732-981-0060 (worldwide); Fax: 732-562-6380
www.ieee.org

IEEE is a not-for-profit association and has more than 400,000 individual members in 160 countries. Through its technical publishing, conferences, and consensus-based standards activities, IEEE produces 30% of the world's published literature in electrical engineering and computers, and control technology.

Motor Decisions MatterSM

Consortium for Energy Efficiency, Inc. (CEE)
98 North Washington Street, Suite 101
Boston, MA 02114-1918
617-589-3949; Fax: 617-589-3948
www.motorsmatter.org

Motor Decisions Matter is a national public awareness campaign that strives to educate corporate and plant decision-makers about the financial and productivity benefits of sound motor management policies. Managed as a special project by CEE, public and private sector sponsors include motor manufacturers, utility and state efficiency program administrators, regional efficiency organizations, and trade associations.

National Electrical Manufacturers Association (NEMA)

1300 North 17th Street, Suite 1752
Roslyn, VA 22209
703-841-3200; Fax: 703-841-5900
www.nema.org

NEMA is the largest trade association for manufacturers of products used in the generation, transmission, distribution, and end-use of electricity. NEMA is a leading developer of voluntary standards for the electric component industry.

Northwest Energy Efficiency Alliance (NEEA)

421 SW Sixth Avenue, Suite 600
Portland, OR. 97204
800-411-0834 or 503-688-5400 Fax: 503-688-5447
<http://neea.org/>

NEEA identifies barriers that impede market adoption, then strategically intervenes to remove those barriers in collaboration with our partners. NEEA works on behalf of more than 100 utilities to help transform the Northwest energy market by creating demand and setting new standards for cost-effective energy efficiency.

Other Resources and Tools

A wide range of information is available on the application and use of drives and motors. This section focuses on the following resources and tools:

- Publications (books, reports, guides, manuals, standards, etc.)
- Software and tools
- Websites
- Periodicals
- Training courses.

For a list of AMO's technical resources and tools, see page 77.

Publications

Achieving More with Less: Efficiency and Economics of Motor Decision Tools

Publisher: Advanced Energy

Available at: www.advancedenergy.org/md/knowledge_library/resources/motor_decision_tools_comprehensive_final_report.pdf

Description: This report presents measured efficiency data from a population of older motors in industry. It also presents load data collected from these motors that will be useful in projecting the savings to be gained from future motor energy conservation efforts.

Adjustable Speed Drive Reference Guide

Authors: Ryan, M.C.; Okrasa, R.

Publisher: Ontario Hydro, 1991

Description: The guide contains chapters on how adjustable speed drives (ASDs) are classified, including physical appearance, principles of operation, comparisons of ASDs, features of ASDs, economics, and harmonic distortion. Uses nontechnical language and is intended for utility representatives or customers who want a short primer on ASDs.

Adjustable Speed Drives Applications Guide, 2nd Edition

Publisher: Electric Power Research Institute

Available at: www.epri.com/abstracts/Pages/ProductAbstract.aspx?ProductId=TR-101140

Description: This report discusses various fundamentals and applications for adjustable speed drives (ASDs) used in residential, commercial, industrial, and utility settings. Fundamentals in alternating-current motors and electronic ASDs are presented as well as applications for specific equipment.

Advanced Electrical Drives: Analysis, Modeling, Control

Authors: De Doncker, R.; Pule, D.; Veltman, A.

Publisher: Springer

Description: In this book, a unique approach is followed to derive model-based torque controllers for direct-current synchronous and induction machines.

Applied Intelligent Control of Induction Motor Drives

Author: Chan, T.F.; Shi, K.

Publisher: Wiley

Description: This book explores new areas of induction motor control based on artificial intelligence (AI) techniques to make the controller less sensitive to parameter changes. Selected AI techniques are applied for different induction motor control strategies. Applications to help all concerned with electric and electronic motor controls. The complete spectrum of motor control applications is examined.

Bonneville Power Administration Publications

Available at: www.bpa.gov/news/pubs/Pages/default.aspx

Complete Handbook of Electric Motor Controls

Author: Traister, J.E.

Publisher: Fairmont Press

Description: Provides information on theory, design, and practical applications to help all concerned with electric and electronic motor controls. The complete spectrum of motor control applications is examined.

Copper Rotor Motor

Publisher: Copper Development Association

Available at: www.copper.org/environment/sustainable-energy/electric-motors/motor-rotor/index.html

Description: Technical papers and other documents that identify and demonstrate design methods, manufacturing process parameters, and durable mold materials that have enabled economical production of die-cast copper rotor motors.

Dynamics and Control of Electrical Drives

Author: Piotr, W.

Publisher: Springer

Description: This book provides the grounds to formulate mathematical models for all lumped parameters' electro-mechanical systems, which are vital in our contemporary industry and civilized everyday life. This practical book concerns modern electrical drives in a broad sense, including electrochemical energy conversion, induction motor drives, and brushless direct-current drives.

EASA-Q: 2000 Quality Manual

Publisher: Electrical Apparatus Service Association (EASA)

Available at: www.easa.com/node/19246

Description: EASA-Q was created to provide EASA members a practical means of developing a quality management system. Based on ISO 9002-2000 quality standard, EASA-Q is designed so that electrical apparatus service organizations can use it with minimal assistance.

The Effect of Repair/Rewinding on Motor Efficiency: EASA/AEMT Rewind Study and Good Practice Guide to Maintain Motor Efficiency

Publishers: Electrical Apparatus Service Association (EASA); Association of Electrical and Mechanical Trades (AEMT)

Available at: www.easa.com/sites/default/files/rwstudy1203.pdf

Description: Based on a joint study by EASA and the AEMT of the United Kingdom, this publication concludes that using best repair/rewind practices maintains motor efficiency. The report provides complete test data, extensive background information about test procedures and methodology, information about best practice repair/rewind procedures, resources for further reading, and an entire chapter on repair/replace considerations.

Electric Drives: Concepts and Applications

Author: Subramanyam, V.

Publisher: Tata McGraw-Hill Publishing Company

Description: This book comprehensively covers the subject of electric drives and their industrial applications. The characteristics and dynamics of electric drives are discussed as well as aspects of control, rating, and heating. Special discussions feature working examples of converters and microprocessors.

Electric Motor Control, 7th Edition

Authors: Alerich, W.N.; Herman, S.L.

Publisher: Delmar Cengage Learning

Description: This book provides explanations of motor control circuits, the hardware that makes up these circuits, applications of motor control circuits in industry, and troubleshooting motor controls. It also includes coverage of relay controls.

Electric Motor Handbook

Authors: Beaty, H.W.; Kirtley, Jr., J.

Publisher: McGraw-Hill Professional

Description: This book provides a full range of information on electric motors used in a variety of consumer, industrial, and commercial applications. It covers data on sizes, shapes, performance, electrical and mechanical parameters, protection, and other factors involved in motor selection and application.

Electric Motor Maintenance and Troubleshooting

Author: Hand, A.

Publisher: McGraw-Hill/TAB Electronics

Description: This book gives an overview of each motor type's components and operation; supplies troubleshooting procedures, which clarifies concepts and reviews questions at the end of each chapter to drive the concepts home. It also covers essential safety issues.

Electric Motor Predictive and Preventive Maintenance Guide

Publisher: Electric Power Research Institute

Available at: www.epri.com/abstracts/Pages/ProductAbstract.aspx?ProductId=NP-7502

Description: This guide provides information on establishing an effective maintenance program to help prevent unexpected motor failures, costly downtime, and unnecessary maintenance costs. Specifically, the guide summarizes technical data relative to four basic power plant motor types and associated components.

Electric Motors and Control Techniques, 2nd Edition

Author: Gottlieb, I.M.

Publisher: Tab Books

Description: This book examines present and theoretical interfaces between motors and their control systems. Its primary focus is on maximizing the efficiency of motors by carefully matching them with well-designed, state-of-the-art controls. Problems with electric vehicles are also discussed.

Electric Motors and Drives: Fundamentals, Types and Applications, 3rd Edition

Author: Hughes, A.

Publisher: Newnes

Description: For nonspecialist users of electric motors and drives, this book explains and compares most of the types currently in use with many examples and applications.

Electric Motors: Energy Efficiency Reference Guide

Author: Keyes, C.

Publisher: CEA Technologies, Inc.

Available at: www.ceati.com/files/Electric%20Motors%20-%20Energy%20Efficiency%20Reference%20Guide%20-%20CEATI.pdf

Description: This guide provides an overview of the major types of electric motors in use today, including direct-current and alternating-current motors. Operating characteristics and physical applications are discussed.

Electric Motors and Motor Controls

Author: Keljik, J.

Publisher: Delmar Cengage Learning

Description: This book provides extensive coverage of electric motors and motor controls, from basic principles of electrical motors controls to more complex “real-world” applications.

Electric Motors and Their Controls: An Introduction

Author: Takashi Kenjo

Publisher: Oxford University Press

Description: This is a translation of the Japanese book, ABC of Motors, describing the principles, construction, and use of different motor types and controllers in simple, nontechnical terms.

Electrician's Technical Reference: Variable Frequency Drives

Author: Carrow, R.

Publisher: Delmar Cengage Learning

Description: This book presents practical information on alternating-current, variable frequency drives (VFDs), how they work, how to apply them, and how to troubleshoot them. Both industrial and commercial VFD applications are addressed, with discussion of installation issues, troubleshooting, metering, sizing and selection, and energy savings with VFDs. Basic theory is explained when necessary.

Electronic Variable Speed Drives, 3rd Edition

Author: Brumbach, M.

Publisher: Delmar Cengage Learning

Description: This book focuses on troubleshooting and maintenance. Different types of drive circuits are explained and practical instruction is emphasized, with little reliance on formulas.

Energy Efficiency Improvements in Electric Motors and Drives

Authors: de Almeida, A.; Bertoldi, P.; Leonhard, W.

Publisher: Springer

Description: This book covers the basics and the state-of-the-art of energy-efficient motor technologies, which can be used now and in the near future to achieve significant and cost-effective energy savings. It describes recent developments in advanced motor technologies such as permanent magnet and reluctance motors. The book presents barriers to the adoption of motor technologies and features policies to promote the large-scale penetration of energy-efficient technologies.

Energy Efficiency in Motor Driven Systems

Authors: Parasiliti, F.; Bertoldi, P.

Publisher: Springer

Description: This book reports the state-of-the-art of energy-efficient electrical motor driven system technologies, which can be used now and in the near future to achieve significant and cost-effective energy savings. It includes the recent developments in advanced electrical motor end-use devices (pumps, fans, and compressors) by some of the largest manufacturers.

Energy Efficiency Policy Opportunities for Electric Motor-Driven Systems

Authors: Waide, P.; Brunner, C.U.

Publisher: International Energy Agency

Available at: www.iea.org/publications/freepublications/publication/EE_for_ElectricSystems.pdf

Description: This paper discusses energy savings technologies used in motor-driven systems, as well as economics and barriers to optimization. It also summarizes policy experience, awareness raising, and provides recommendations for new policies.

Energy-Efficient Drivepower: An Overview

Author: Ula, S. et al.

Publisher: U.S. Department of Energy (DOE)

Available at: www.ntis.gov/search/product.aspx?ABBR=DE93012435

Description: This document was prepared in a three-way cooperative effort between the Bonneville Power Administration, the DOE Denver Regional Support Office, and the Western Area Power Administration. The report examines energy efficiency in systems that are driven by electric motors. It includes sections on motors, controls, electrical tune-ups, mechanical efficiency, maintenance, cooling, cleaning, and management, as well as estimates of the combined effects of using a system approach in improving the efficiency of motor-driven equipment. This report is largely a condensation of a report titled The State of the Art: Drivepower, which is described elsewhere in this section.

Energy-Efficient Electric Motors, 3rd Edition, Revised and Expanded

Author: Emadi, A.

Publisher: CRC Press

Description: This detailed reference provides guidelines for the selection and utilization of electric motors for improved reliability, performance, energy efficiency, and life cycle cost. Completely revised and expanded, the book reflects the recent state of the field, as well as recent developments in control electronics, the economics of energy-efficient motors and systems, and advanced power electronic drivers. It includes five new chapters covering key topics such as the fundamentals of power electronics applicable to electric motor drives, adjustable speed drives and their applications, advanced switched-reluctance motor drives, and permanent magnet and brushless direct-current motor drives.

Energy-Efficient Electric Motors and Their Applications, 2nd Edition

Author: Jordan, H.E.

Publisher: Springer

Description: Evaluates the energy savings potential of different energy efficient motors. It examines all aspects of motor and adjustable speed drive technology, and provides a step-by-step description of the process of selecting and applying motors. Also included are chapters on efficiency verification, power factor, and alternating-current motor control.

Energy-Efficient Motor Systems: A Handbook on Technology, Program, and Policy Opportunities, 2nd Edition

Authors: Nadel, S.; Elliott, R.N.; Shepard, M.; Greenberg, G.K.; de Almeida, A.T.

Publisher: American Council for an Energy-Efficient Economy

Available at: www.aceee.org/ebook/energy-efficient-motor-systems

Description: This book outlines a systems approach encompassing high-efficiency motors, optimized controls, improved component monitoring, and maintenance. Full application of the measures described here can cut U.S. electricity demand by 27% to 40%, save motor users and utilities billions of dollars, reduce pollutant emissions, and enhance productivity.

Horsepower Bulletin

Publisher: Advanced Energy

Available at: http://www.advancedenergy.org/md/knowledge_library/resources/Horsepower%20Bulletin.pdf

Description: This bulletin outlines a policy for cost-effective management of motor purchase and repair and is based on comments from industrial customers, electric utilities, motor suppliers, and repair shops.

WHERE TO FIND HELP

IEEE Standard for Petroleum and Chemical Industry—Severe Duty Totally Enclosed Fan-Cooled (TEFC) Squirrel-Cage Induction Motors—Up to and Including 370 kW (500 hp)

Publisher: Institute of Electrical and Electronics Engineers (IEEE)

Available at: <http://ieeexplore.ieee.org/stamp/stamp.jsp?tp=&arnumber=929431>

Description: This standard applies to high-efficiency TEFC, horizontal and vertical, single-speed, squirrel-cage polyphase induction motors, up to and including 370 kilowatts (kW) [500 horsepower (hp)], in National Electrical Manufacturers Association frame sizes 143T and larger, for petroleum, chemical, and other severe duty applications (commonly referred to as severe duty motors). Excluded from the scope of this standard are motors with sleeve bearings and additional specific features required for explosion-proof motors.

Induction Motor Drives: Principles, Control, and Implementation

Author: Chakraborty, C.; Maiti, S.

Publisher: CRC Press

Description: This book introduces the principles of operation and the implementation of controllers for induction motor drives through both simulation and experimental results. It deals with some important topics associated with induction motor drives, and it introduces basic types of controllers.

Industrial Motor Control, 6th Edition

Authors: Herman, S.

Publisher: Delmar Cengage Learning

Description: This book provides easy-to-follow instructions and essential information for controlling industrial motors. It covers most commonly used devices in contemporary industrial settings. Many circuits explained with step-by-step sequences, which will help students learn the concepts and applications of control logic.

Industrial Power Factor Analysis Guidebook

Publisher: Bonneville Power Administration

Description: This guidebook gives utility staff, industrial end-users, and others a step-by-step method for evaluating the cost-effectiveness of installing power factor correction capacitors.

Managing Motors, Second Edition

Author: Nailen, R. L.

Publisher: Barks Publications, Inc. (out of print)

Description: This book covers standards and specifications, efficiency, power factor, and starting conditions. The middle portion considers motor application, explaining how motors are best matched to their power systems and operating environments. Also it looks at components—such as insulation, windings, and bearings—and describes optional accessories and proper installation practices.

Modern Electric/Electronic Motors

Author: Martin Clifford

Publisher: Prentice Hall

Description: This book describes the history and growth of motors. The opening chapter describes the development of the electric motor and the fundamental principles of magnetism. The second chapter details the physical and electrical characteristics of motors in general. The remaining chapters look at the following technologies in detail: direct-current (DC) motors, alternating-current motors, and electronics for motors, brushless DC motors, stepping motors, and mechanical drives. This text is intended for the reader with a technical background who wants an understanding of the way motors work. It is somewhat geared towards the reader who wishes to become involved in motor repair, as it contains sections on troubleshooting for each motor type. However, it is also a good general reference text on motors, although energy efficiency issues are not emphasized.

Modern Industrial Electrical Motor Controls: Operation, Installation, and Troubleshooting

Authors: Kissell, T.E.; Hicks, C.

Publisher: Prentice Hall

Description: This book covers the theory of operation, installation, and troubleshooting of motor controls and motors. It includes hundreds of pictures and diagrams pertaining to the operation and interfacing of motor controls.

Motor Control Electronics Handbook

Author: Valentine, R.

Publisher: McGraw-Hill Professional

Description: This book describes reliable electronic controls for any motor application. It assists in the design of motor controls with microcontrollers and insulated-gate bipolar transistor power devices, and provides an introduction to digital motor-speed controls. It also describes step-by-step practical methods for reducing electromagnetic interference problems and provides information about control's reliability and insights into motor control diagnostics. Other topics include direct-current and alternating-current motor control designs; automotive and appliance motor controls; digital controls; power semiconductors; microcontrollers; communication networks; and motor control test procedures.

Motor Efficiency, Selection, and Management: A Guidebook for Industrial Efficiency Programs

Author: Emanuele, K.A.

Publisher: Consortium for Energy Efficiency, 2011

Available at: http://cms.cee1.org/sites/default/files/library/9322/CEEMotorGuidebook_2.pdf

Description: This guide provides information on how to “get started” with a motor management plan, including the identification of key motor and system efficiency opportunities. It also contains an introduction to cost savings with adjustable speed drives.

Motor Management Best Practices

Publisher: Copper Development Association, 2012

Description: These best practices include:

Part I: Creating a Motor Inventory, Repair/Replace Guidelines

Available at: www.copper.org/environment/sustainable-energy/electric-motors/case-studies/a6141/a6141.pdf

Part II: Motor Failure Policies and Purchasing Specifications

Available at: www.copper.org/environment/sustainable-energy/electric-motors/case-studies/a6148/a6148.pdf

Part III: Repair Specifications, and Preventive and Predictive Maintenance

Available at: www.copper.org/environment/sustainable-energy/electric-motors/case-studies/a6150/a6150.pdf

Motor MEPS Guide (2009)

Authors: Boteler; Brunner; De Almeida; Doppelbauer; Hoyt

Publisher: 4E

Available at: www.motorsystems.org/files/otherfiles/0000/0038/MEPS_Guide_1st_Edition_February_2009.pdf

Description: This guide describes the International Electrotechnical Commission's motor testing standards, efficiency classes (IE1, IE2, IE3), and labels necessary to recognize high-efficiency products in the marketplace.

Motor Policy Guide, Part 1: Assessment of Existing Policies (2011)

Authors: Kulterer, K.; Werle, R.

Publisher: 4E

Available at: www.motorsystems.org/files/otherfiles/0000/0099/motor_policy_guide_aug2011.pdf

Description: This publication presents a survey of existing motor systems policies and programs designed to capture existing energy savings opportunities in the industrial and service sectors. The survey includes national mandatory minimum energy performance standards, audit schemes, training, and financial incentives to encourage investing in efficient equipment.

Motor Planning Kit, Version 2.1

Publisher: Consortium for Energy Efficiency

Available at: www.motorsmatter.org/tools/mpkv21.pdf

Description: It is a resource for those interested in developing a motor management plan. The brochure provides step-by-step guidelines, tools, and resources for developing and implementing a customized plan that suits individual organizational needs.

Motor Systems Efficiency Supply Curves

Authors: McKane, A.; Hasanbeigi, A.

Publisher: United Nations Industrial Development Organization

Available at: [www.unido.org/fileadmin/user_media/Services/Energy_and_Climate_Change/Energy_Efficiency/CCS/UNIDO%20-%20UN-Energy%20-%202010%20-%20Motor%20Systems%20Efficiency%20Supply%20Curves%20\(2\).pdf](http://www.unido.org/fileadmin/user_media/Services/Energy_and_Climate_Change/Energy_Efficiency/CCS/UNIDO%20-%20UN-Energy%20-%202010%20-%20Motor%20Systems%20Efficiency%20Supply%20Curves%20(2).pdf)

Description: The book develops a methodology for quantifying the motor and systems energy savings potential by country and region. The methodology is applied to estimate pumping, fan, and compressed air system savings in six regions, composed of developed, emerging, and developing countries.

Motors Reference Guide

Authors: Dederer, D.H.; Rouse, S.

Publisher: Ontario Hydro, 1997

Description: This report contains chapters on how motors are classified, principles of operation, selection of motors, motor controls, and maintenance of motors. It uses non-technical language and is intended for utility representatives or customers who want a short primer on motors.

Permanent Magnet Motor Technology Revised

Authors: Gieras, J.; Wing, M.

Publisher: CRC Press

Description: This book demonstrates the construction of permanent-magnet (PM) motor drives and supplies ready-to-implement solutions for common roadblocks. The author presents fundamental equations and calculations to determine and evaluate system performance, efficiency, and reliability; explores modern computer-aided design of PM motors, including the finite element approach; and covers how to select PM motors to meet the specific requirements of electrical drives.

Power Electronics and Motor Drives: Advances and Trends

Author: Bose, B.K.

Publisher: Academic Press

Description: Power electronics is an area of extremely important and rapidly changing technology. Technological advancements in the area contribute to performance improvement and cost reduction, with applications proliferating in industrial, commercial, residential, military and aerospace environments. This book is meant to help engineers operating in all these areas stay up-to-date on the most recent advances in the field, as well as to be a vehicle for clarifying increasingly complex theories and mathematics.

Power Electronics and Motor Control, 2nd Edition

Authors: Shepherd, W.; Hulley, L.N.; Liang, D. T. W.

Publisher: Cambridge University Press

Description: This edition includes a new chapter on the application of pulse-width modulation techniques in induction motor speed control in this second edition of a comprehensive introduction to power electronics.

Power Electronics and Motor Drives

Author: Wilamowski, B.

Publisher: CRC Press

Description: This book offers specialized knowledge that will help industrial electronics engineers develop practical solutions for the design and implementation of high-power applications. This book explores fundamental areas, including analog and digital circuits, electronics, electromagnetic machines, signal processing, and industrial control and communications systems. It also facilitates the use of intelligent systems—such as neural networks, fuzzy systems, and evolutionary methods—in terms of a hierarchical structure that makes factory control and supervision more efficient.

Power Electronics and Variable Frequency Drives: Technology and Applications

Editor: Bose, B.K.

Publisher: Wiley-IEEE Press

Description: This compendium of papers from 11 well-known professionals provides comprehensive coverage of power electronics and alternating-current (AC) drive technology. Topics covered include power semiconductor devices, electrical machines, converter circuits, pulse-width modification techniques, AC machine drives, simulation techniques, estimation and identification, microprocessors, and artificial intelligence techniques.

Practical Electric Motor Handbook

Author: Gottlieb, I.

Publisher: Newnes

Description: Shows engineers and designers how to incorporate electric motors into their products, taking their expertise into account. The book offers a practical approach with minimum theory, and shows how motors can be utilized in various types of electric circuits and products.

Practical Machinery Management for Process Plants, Volumes 1-4

Authors: Bloch, H.P.; Geitner, F.K.

Publisher: Gulf Professional Publishing

Description: It's a four-volume series of books for machinery management at process plants:

- Improving Machinery Reliability, Volume 1
- Machinery Failure Analysis and Troubleshooting, Volume 2
- Machinery Component Maintenance and Repair, Volume 3
- Major Process Equipment Maintenance and Repair, Volume 4.

Each volume provides a thorough analysis of its respective title subject with field-proven techniques, graphs, and illustrations.

Practical Variable Speed Drives and Power Electronics

Author: Barnes, M.

Publisher: Newnes

Description: This book provides a fundamental understanding of the installation, operation, and troubleshooting of variable speed drives, including coverage of control wiring, operating modes, braking types, automatic restart, harmonics, electrostatic discharge, and electromagnetic compatibility and interference issues.

Recommended Practice for the Repair of Rotating Electrical Apparatus, EASA Standard AR100-2010

Author: Electrical Apparatus Service Association; American National Standards Institute,

Available at: www.easa.com/techarticles/AR100-2010

Description: The purpose of this document is to establish recommended practices for each step of rotating electrical apparatus rewinding and rebuilding.

Sensor Characteristics Reference Guide

Authors: J. Cree., R. Muehleisen, A. Dansu, M. Starke, P. Fuhr, P. Banerjee, S. Lanzisera, T. Kuruganti, T. McIntyre, C. Castello

Editor: S. McDonald

Publisher: The Department of Energy

Available at: http://www1.eere.energy.gov/buildings/technologies/pdfs/sensor_characteristics_reference_guide.pdf

Description: The guide does not advocate for any particular approach to implementation of a sensor or control system in various facilities and power scenarios. Instead, the goal is to better inform owners and operators as to the features, benefits, and limitations of these various approaches. It is hoped that a better informed consumer will make an informed choice given the particulars of their needs.

The State of the Art: Drivepower

Author: Lovins, A.B. et al.

Publisher: Rocky Mountain Institute/Competitek

Description: This report critically reviews diverse data on drivepower usage, the documented cost and performance of the best equipment available; and practices for providing unchanged or improved motor torque with less input energy. It compares empirical savings for more than 30 energy saving options and explores their numerous interactions.

Variable Frequency AC Motor Drive Systems

Author: Finney, D.

Publisher: The Institution of Engineering and Technology

Available at: www.theiet.org/resources/books/pow-en/19161.cfm

Description: This book covers various types of alternating-current motors, along with their power switching devices, inverters, converters and slip energy recovery systems.

Variable Speed Drive Fundamentals, 3rd Edition

Author: Phipps, C.A.

Publisher: Fairmont Press

Description: This book does not go into complex mathematical equations, but establishes basic relationships and rules of thumb helpful in relatively simple drive system applications. It is intended for technicians without a mathematical background.

Variable Speed Drives: Principles and Applications for Energy Cost Savings

Author: Spitzer, D.W.

Publisher: International Society of Automation

Available at: www.isa.org/Template.cfm?Section=Shop_ISA&Template=/Ecommerce/ProductDisplay.cfm&ProductID=6963

Description: Many applications of variable speed drive (VSD) technology fall in the cracks between traditional engineering disciplines. This new edition of a venerable classic incorporates the additional insights of the author to help practicing engineers learn about the technical and economic potential of this technology. It presents the electrical, hydraulic, chemical, and instrumentation information necessary to technically evaluate and economically justify VSD applications.

Walking the Torque: Proposed Work Plan for Energy-Efficiency Policy Opportunities for Electric Motor-Driven Systems

Authors: Falkner, H.; Holt, S.

Publisher: International Energy Association

Available at: www.iea.org/publications/freepublications/publication/Walking_the_Torque.pdf

Description: This book discusses energy use in electric motor-driven systems by sector and country. It identifies system optimization issues and barriers to the uptake of efficiency.

Software and Tools

The Motor Systems Tool

Developer: 4E

Available at: www.motorsystems.org/motor-systems-tool

Description: It consists of a full motor system from power supply to application. From one known duty point all partials are calculated as well as the total system efficiency. Any change in speed, load or components is calculated dynamically and results are presented instantly.

The 1-2-3 Approach to Motor Management

Publisher: Consortium for Energy Efficiency

Available at: www.motorsmatter.org/tools/123approach.html

Description: The 1-2-3 Approach is an introductory tool designed as a gateway to more comprehensive motor management tools and strategies. As part of this approach, the Microsoft Excel™ spreadsheet showcases the benefits of proactive motor management.

Additional Websites of Interest

Electric Motors Reference Center

Publisher: Penton Media, Inc., and Machine Design Magazine

Available at: www.electricmotors.machinedesign.com

Description: This online reference center for information on electric motors includes descriptions of different alternating-current and direct-current motor types, information on suppliers, and recent articles on electric motors.

Motors and Drives

Publisher: Carbon Trust

Available at: www.carbontrust.com/resources/guides/energy-efficiency/motors-and-drives

Description: This Web page provides a technology overview plus covers opportunities for energy savings with motors, power transmission systems, new equipment, and with management policies.

Periodicals

ASHRAE Journal

Publisher: American Society of Heating, Refrigerating, and Air-Conditioning Engineers (ASHRAE)

Available at: www.ashrae.org/resources--publications/periodicals/ashrae-journal

Consulting-Specifying Engineer

Publisher: CFE Media

Available at: www.csemag.com

IEEE Journals and Magazines

Publisher: Institute of Electrical and Electronics Engineers (IEEE)

Available at: <http://ieeexplore.ieee.org/xpl/periodicals.jsp>

Industrial Maintenance & Plant Operation (IMPO)

Publisher: Advantage Business Media

Available at: www.impomag.com

Machine Design Magazine

Publisher: Penton Media, Inc.

Available at: <http://machinedesign.com>

Mechanical Engineering Magazine

Publisher: American Society of Mechanical Engineers

Available at: <http://memagazine.asme.org/>

Plant Engineering Magazine

Publisher: CFE Media

Available at: www.plantengineering.com

Training Courses

Association of Energy Engineers Seminars

Available at: www.aeeprograms.com/store/category.cfm?category_id=4

Electrical Apparatus Service Association Education

Available at: www.easa.com/education

Institute of Electrical and Electronics Engineering

Available at: www.ieee.org/education_careers/index.html

APPENDICES

This sourcebook contains the following appendices:

Appendix A: Motor Tip Sheets

It lists tip sheets developed to increase users' awareness of potential performance benefits and energy savings that can be obtained by improving the efficiency of motor and drive systems.

Appendix B: Minimum Full-Load Efficiency Standards for Energy Efficient and Premium Efficiency Motors

It provides minimum full-load efficiency standards for energy-efficient and premium efficiency motors for a range of motor horsepower ratings, synchronous speeds, and enclosure types.

Appendix C: Motor Repair Service Center Checklist

It features a checklist for motor repair facilities.

Appendix A: Motor Systems Energy Tip Sheets

The U.S. Department of Energy Advanced Manufacturing Office (AMO) has developed Motor Systems Energy Tips sheets, which discuss opportunities for improving the efficiency and performance of motor systems. The following motor tip sheets are available on the AMO website:

#1 - When to Purchase Premium Efficiency Motors

www.eere.energy.gov/manufacturing/tech_deployment/pdfs/whentopurchase_nema_motor_systemts1.pdf

#2 - Estimating Motor Efficiency in the Field

www.eere.energy.gov/manufacturing/tech_deployment/pdfs/estimate_motor_efficiency_motor_systemts2.pdf

#3 - Extend the Operating Life of Your Motor

www.eere.energy.gov/manufacturing/tech_deployment/pdfs/extend_motor_operlife_motor_systemts3.pdf

#4 - The Importance of Motor Shaft Alignment

www.eere.energy.gov/manufacturing/tech_deployment/pdfs/importance_motor_shaft_motor_systemts4.pdf

#5 - Replace V-Belts with Notched or Synchronous Belt Drives

www.eere.energy.gov/manufacturing/tech_deployment/pdfs/replace_vbelts_motor_systemts5.pdf

#6 - Avoid Nuisance Tripping with Premium Efficiency Motors

www.eere.energy.gov/manufacturing/tech_deployment/pdfs/avoid_nuisance_motorsys_ts6.pdf

#7 - Eliminate Voltage Unbalance

www.eere.energy.gov/manufacturing/tech_deployment/pdfs/eliminate_voltage_unbalanced_motor_systemts7.pdf

#8 - Eliminate Excessive In-Plant Distribution System Voltage Drops

www.eere.energy.gov/manufacturing/tech_deployment/pdfs/motor_tip_sheet8.pdf

#9 - Improve Motor Operation at Off-Design Voltages

www.eere.energy.gov/manufacturing/tech_deployment/pdfs/motor_tip_sheet9.pdf

#10 - Turn Motors Off When Not in Use

www.eere.energy.gov/manufacturing/tech_deployment/pdfs/motor_tip_sheet10.pdf

#11 - Adjustable Speed Drive Part-Load Efficiency

www.eere.energy.gov/manufacturing/tech_deployment/pdfs/motor_tip_sheet11.pdf

#12 - Is it Cost-Effective to Replace Old Eddy-Current Drives?

www.eere.energy.gov/manufacturing/tech_deployment/pdfs/motor_tip_sheet12.pdf

#13 - Magnetically Coupled Adjustable Speed Motor Drives

www.eere.energy.gov/manufacturing/tech_deployment/pdfs/motor_tip_sheet13.pdf

#14 - When Should Inverter-Duty Motors Be Specified?

www.eere.energy.gov/manufacturing/tech_deployment/pdfs/motor_tip_sheet14.pdf

#15 - Minimize Adverse Motor and Adjustable Speed Drive Interactions

www.eere.energy.gov/manufacturing/tech_deployment/pdfs/motor_tip_sheet15.pdf

For all of AMO's resources on motor systems, visit its website.⁸⁰

⁸⁰ www.eere.energy.gov/manufacturing/tech_deployment/motors.html

APPENDICES

Appendix B: Minimum Full-Load Efficiency Standards for Energy-Efficient and Premium Efficiency Motors

Under the Energy Independence and Security Act (EISA) of 2007, the mandatory minimum nominal full-load efficiency for low-voltage general-purpose motors with a power rating up to 200 horsepower (hp) was raised to the National Electrical Manufacturers Association (NEMA) Premium® efficiency level as given in Table 12-12 of NEMA MG 1-2011. The premium efficiency requirement applies to motors purchased alone, imported into the country, or purchased as a component of another piece of equipment.

EISA applies to general purpose, T-Frame, single-speed, foot-mounted, continuous-rated, polyphase squirrel-cage induction motors of NEMA Designs A and B. The subject motors are designed to operate on 230/460 volts (V) and 60 hertz, and have open and closed enclosures. It also applies to 6-pole [1,200 revolutions per minute (RPM)], 4-pole (1,800 RPM), and 2-pole (3,600 RPM) open and enclosed motors rated 1 through 200 hp. The act does not apply to definite-purpose motors (i.e., those designed for use under unusual conditions or for use on a particular type of application, which cannot be used in most general applications) or special purpose motors (i.e., those designed for a particular application with special operating characteristics or mechanical construction).

EISA also requires that NEMA Design B motors with power ratings between 201 and 500 hp shall have a full-load efficiency that meets or exceeds the NEMA energy-efficient motor standards (given in Table 12-11 of NEMA MG 1-2011). End-users may voluntarily purchase NEMA Premium efficiency motors in these ratings. The EISA motor efficiency mandates took effect in December 2010.

Additionally, EISA expanded the term “general purpose” motor to include a number of motor subtypes that were not covered by earlier motor efficiency standards. These motor subtypes now must have full-load efficiency values

that meet or exceed the NEMA energy-efficient motor standards. Motors in the 1 hp to 200 hp ratings that are covered by this mandatory efficiency standard include:

- U-Frame motors
- Design C motors
- Closed-coupled pump motors
- Footless (C-face or D-flange without base) motors
- Vertical solid-shaft, normal-thrust motors (P-base)
- 7-pole (900 RPM) motors
- Polyphase motors with a voltage of not more than 600 V (other than 230- or 460-V motors). This applies to 200-V and 575-V motor model lines
- Fire-pump motors.

The NEMA Motor and Generator Section established a premium energy efficiency motors standard to provide highly energy-efficient products that meet the needs and applications of users and original equipment manufacturers based on a consensus definition of “premium efficiency.” Premium efficiency motors are more efficient than equivalent-rated motors that meet the NEMA energy-efficient standard levels as given in Table 12-11 of NEMA Standards Publication MG 1-2011.

The premium efficiency electric motor standard applies to single-speed continuously rated NEMA Design A and B polyphase squirrel cage 2, 4, and 6-pole induction motors rated for 1-500 hp. Products must meet or exceed the nominal energy efficiency (EE) levels presented below in tables C-1, C-2, C-3, and C-4. The NEMA Premium efficiency levels are contained in Tables 12-12 and 12-13 of NEMA Standards Publication MG 1- 2011.

APPENDICES

Table B-1. Nominal Efficiencies for Open Drip-Proof Induction Motors Rated 600 V or Less

Nominal Efficiencies for NEMA Premium® Induction Motors Rated 600 Volts or Less (Random Wound)						
hp	Open Drip-Proof					
	1200 RPM (6-pole)		1800 RPM (4-pole)		3600 RPM (2-pole)	
	EPAAct*	NEMA Premium	EPAAct*	NEMA Premium	EPAAct*	NEMA Premium
1	80.0	82.5	82.5	85.5	N/A	77.0
1.5	84.0	86.5	84.0	86.5	82.5	84.0
2	85.5	87.5	84.0	86.5	84.0	85.5
3	86.5	88.5	86.5	89.5	84.0	85.5
5	87.5	89.5	87.5	89.5	85.5	86.5
7.5	88.5	90.2	88.5	91.0	87.5	88.5
10	90.2	91.7	89.5	91.7	88.5	89.5
15	90.2	91.7	91.0	93.0	89.5	90.2
20	91.0	92.4	91.0	93.0	90.2	91.0
25	91.7	93.0	91.7	93.6	91.0	91.7
30	92.4	93.6	92.4	94.1	91.0	91.7
40	93.0	94.1	93.0	94.1	91.7	92.4
50	93.0	94.1	93.0	94.5	92.4	93.0
60	93.6	94.5	93.6	95.0	93.0	93.6
75	93.6	94.5	94.1	95.0	93.0	93.6
100	94.1	95.0	94.1	95.4	93.0	93.6
125	94.1	95.0	94.5	95.4	93.6	94.1
150	94.5	95.4	95.0	95.8	93.6	94.1
200	94.5	95.4	95.0	95.8	94.5	95.0
250		95.4		95.8		95.0
300		95.4		95.8		95.4
350		95.4		95.8		95.4
400		95.8		95.8		95.8
450		96.2		96.2		95.8
500		96.2		96.2		95.8

APPENDICES

Table B-2. Nominal Efficiencies for Totally Enclosed Fan-Cooled Induction Motors

Efficiencies for NEMA Premium® Induction Motors Rated 600 Volts or Less (Random Wound)						
hp	Totally Enclosed Fan-Cooled					
	1200 RPM (6-pole)		1800 RPM (4-pole)		3600 RPM (2-pole)	
	EPAc*	NEMA Premium	EPAc*	NEMA Premium	EPAc*	NEMA Premium
1	80.0	82.5	82.5	85.5	75.5	77.0
1.5	85.5	87.5	84.0	86.5	82.5	84.0
2	86.5	88.5	84.0	86.5	84.0	85.5
3	87.5	89.5	87.5	89.5	85.5	86.5
5	87.5	89.5	87.5	89.5	87.5	88.5
7.5	89.5	91.0	89.5	91.7	88.5	89.5
10	89.5	91.0	89.5	91.7	89.5	90.2
15	90.2	91.7	91.0	92.4	90.2	91.0
20	90.2	91.7	91.0	93.0	90.2	91.0
25	91.7	93.0	92.4	93.6	91.0	91.7
30	91.7	93.0	92.4	93.6	91.0	91.7
40	93.0	94.1	93.0	94.1	91.7	92.4
50	93.0	94.1	93.0	94.5	92.4	93.0
60	93.6	94.5	93.6	95.0	93.0	93.6
75	93.6	94.5	94.1	95.4	93.0	93.6
100	94.1	95.0	94.5	95.4	93.6	94.1
125	94.1	95.0	94.5	95.4	94.5	95.0
150	95.0	95.8	95.0	95.8	94.5	95.0
200	95.0	95.8	95.0	96.2	95.0	95.4
250		95.8		96.2		95.8
300		95.8		96.2		95.8
350		95.8		96.2		95.8
400		95.8		96.2		95.8
450		95.8		96.2		95.8
500		95.8		96.2		95.8

APPENDICES

Table B-3. Nominal Efficiencies for Open Drip-Proof Induction Motors Rated 5 kV or Less

Nominal Efficiencies for NEMA Premium® Induction Motors Rated Medium Volts—5kV or Less (Form Wound)			
Open Drip-Proof			
hp	6-pole	4-pole	2-pole
250–500	95.0	95.0	94.5

Table B-4. Nominal Efficiencies for Totally Enclosed Fan-Cooled Induction Motors Rated 5 kV or Less

Nominal Efficiencies for NEMA Premium® Induction Motors Rated Medium Volts—5kV or Less (Form Wound)			
Totally Enclosed Fan-Cooled			
hp	6-pole	4-pole	2-pole
250–500	95.0	95.0	95.0

Appendix C: Motor Repair Service Center Checklist

The first two parts of the checklist assess service center capability. These respectively assess capacity capability and specific capability. Capacity pertains mainly to the size of motors that can be accommodated. Specific capability pertains mainly to the ability to repair what may not routinely be part of all motor rebuilds. Limitations of these capabilities do not necessarily indicate efficiency or quality problems for repair jobs not requiring those capabilities.

Capacity Capability (for multiple devices, list maximum capability of each)

What is the largest motor for which the service center is fully equipped to rewind and test in-house?

	Rewind Capability	Testing
Weight		
Length		
Diameter		
Horsepower		
Voltage		

Record Keeping

How long does service center keep records on each repaired motor? (Obtain sample copy of filled-in job card or computer printout.)

Specific Repair Capability

Check services offered:

- Random wound polyphase ac motor repair
- Form wound polyphase ac motor repair
- dc motor repair
- Single-phase motor repair
- Machine shop capability

APPENDICES

<p>What primary methods of winding removal are used?</p> <ul style="list-style-type: none"> <input type="checkbox"/> Controlled Burn-out; typical temperature ____°F (If sometimes higher, explained circumstances.) <input type="checkbox"/> Chemical Stripping <input type="checkbox"/> Mechanical Pulling at temperature under 400°F <input type="checkbox"/> Other 	<p>Burnout most common. Best if core kept under 680°F.</p> <p>Mechanical pulling at reduced temperature can flare laminations and increase stray loads. It is rare in United States.</p>
<p>How does the service center ensure that the correct wire sizes and types are available for rewinding?</p> <p>What does the service center do if exact wire size is not in inventory?</p>	<p>Evidence of quick availability of all round wire sizes is important. Availability from in-house stock, quick pipeline to supplier, or explanation of stranding to replicate original circular mills can all be acceptable. Wire should be inverter grade if inverter powered motors will be rewound.</p>
<p>On random wound motors, is winding pattern ever revised for reasons other than customer ordered redesign?</p> <ul style="list-style-type: none"> <input type="checkbox"/> Yes <input type="checkbox"/> No If yes, what changes? <input type="checkbox"/> Lap to concentric <input type="checkbox"/> Concentric to lap <input type="checkbox"/> Other (explain) 	<p>It is best to replicate the original winding pattern. However, it can be difficult to replicate some stator windings. Service center should have policies and technical guides to ensure original or better motor performance.</p>
<p>How many employees have the following years of experience?</p> <ul style="list-style-type: none"> ____ More than 8 years ____ 4-8 years ____ Less than 4 years 	<p>Desirable to have 20% or more with more than 4 years experience.</p>
<p>What sort of supplemental training or professional development activity is offered to service center employees? (Obtain evidence if possible.)</p> <ul style="list-style-type: none"> <input type="checkbox"/> In-house training or structured mentoring (Describe) <input type="checkbox"/> Off-site short courses, workshops or seminars one or more days in length <input type="checkbox"/> Subsidized evening or part-time classes at college or trade school <input type="checkbox"/> Attendance at trade conferences or conventions <input type="checkbox"/> Other 	<p>Participation in job-related trainings is commendable. EASA offers many training courses and holds an annual convention.</p>
<p>How much training or professional development do service center employees receive?</p> <ul style="list-style-type: none"> ____ Percentage of employees receiving off-site training annually ____ Average days off-site per year per employee receiving off-site training ____ Annual training expenditure per employee receiving off-site training 	<p>A training program culture involving formal internal or off-site training is desirable. Monitoring for continuous improvement such as tracking scrap rate and completed motor test results contributes to a more competent and careful staff.</p> <p>At least 10% should receive annual off-site training.</p> <p>One or more days off-site desirable.</p> <p>\$300 or more per employee desirable.</p>

APPENDICES

<p>In what trade or professional associations does service center have membership? _____ _____</p>	<p>EASA membership is a definite plus, although very large service centers may have in-house capability to provide similar benefits.</p>
<p>What temperature classes of insulation are stocked and used? _____ _____</p>	<p>F or H desirable.</p>
<p>What (if any) kind of core loss testing does service center use?</p> <p><input type="checkbox"/> Loop or ring test; max kVA _____</p> <p><input type="checkbox"/> Commercial tester; max kVA _____</p> <p>How often do they use it? _____</p> <p>Are test records kept on permanent file?</p> <p><input type="checkbox"/> Yes <input type="checkbox"/> No</p>	<p>Using a tester on all motors is evidence that service center is conscientious about core losses.</p>
<p>How are results used? Check all that apply:</p> <p><input type="checkbox"/> Check for hot spots to be repaired</p> <p><input type="checkbox"/> Note watts per pound and compare to a standard</p> <p><input type="checkbox"/> Document impact of burnout/rewind to customer</p>	<p>Certainly check for hot spots. Noting watts per pound and comparison to standard or before and after testing is commendable.</p>
<p>Is no-load testing done on all motors?</p> <p><input type="checkbox"/> Yes <input type="checkbox"/> No</p>	<p>This should be mandatory for operational motors. If not, determine why not. Test should verify rotation at nameplate speed in the correct direction and check for abnormal sounds. It should also ensure that vibration and bearing temperature are not abnormally high.</p>

Equipment Calibration

Item	Normal interval	Date last calibrated or certified	
Ammeters			Annual
Wattmeters			Annual
Core Loss Tester			Annual
Burnout oven temp.			Annual
Micrometers & Calipers			Annual OK; 6 months better. May be done in-house to certified clean dry standard blocks.
Megohmmeter			Annual
Voltmeter			Annual

APPENDICES

<p>Surge Comparison Tester Brand _____ Model _____</p>	<p>Annual</p>
<p>ac Power Supply Voltage Range _____ kVA _____ Continuously variable voltage? _____</p>	<p>Annual on volts, amps, and power factor or watts unless these are monitored by the portable instruments above.</p>
<p>dc Power Supply Voltage Range _____ kVA _____ Continuously variable voltage? _____</p>	<p>Annual on volts, amps, or watts unless these are monitored by the portable instruments above.</p>
<p>What % of motor rewind jobs get core loss testing both before and after rewinding? _____%</p>	<p>Ideally 100%. Explain lower percentages.</p>
<p>Varnish and resins spec. _____ spec. _____ spec. _____ spec. _____</p> <p>Vibration Analysis Equipment Brand _____ Model _____</p> <p>High Potential Tester (HiPot) Brand _____ Model _____ ac rating _____ dc rating _____</p>	<p>Sample should have been taken and analyzed every 2-3 months, to ensure no degradation from aging.</p> <p>Manufacturer's material specs should be on file.</p> <p>Annual.</p> <p>Annual to a certified standard resistance.</p>

Documents and Record Keeping

Check whether current copies of all the following documents are present. The publication dates shown below are current as of this printing:

*American National Standards Institute (ANSI)/
National Electric Manufacturers Association
(NEMA) MG1-2011 Motors and Generators*

Available at: [www.nema.org/Standards/
ComplimentaryDocuments/Contents%20and%20
Forward%20MG%201.pdf](http://www.nema.org/Standards/ComplimentaryDocuments/Contents%20and%20Forward%20MG%201.pdf)

*Institute of Electrical and Electronics Engineers
(IEEE) Std 43-2000 Recommended Practice
for Testing Insulation Resistance of Rotating
Machinery*

Available at: [http://ieeexplore.ieee.org/servlet/
opac?punumber=6740](http://ieeexplore.ieee.org/servlet/opac?punumber=6740)

*American Bearing and Manufacturers Association
(ABMA) Standard 7: Shaft and Housing Fits for
Metric Radial Ball and Roller Bearings, 1995*

Available at: [www.americanbearings.
org/?page=standards](http://www.americanbearings.org/?page=standards)

*IEEE Std 112--2004 Test Procedures for Polyphase
Induction Motors and Generators*

Available at: [http://ieeexplore.ieee.org/servlet/
opac?punumber=9367](http://ieeexplore.ieee.org/servlet/opac?punumber=9367)

*ABMA Standard 20: Radial Bearings of Ball,
Cylindrical Roller and Spherical Roller
Types – Metric Design, 2011*

Available at: [www.americanbearings.
org/?page=standards](http://www.americanbearings.org/?page=standards)

*IEEE Std 432-1992 Insulation Maintenance for
Rotating Electric Machinery [5 horsepower (hp)
to Less Than 10,000 hp]*

Available at: [http://ieeexplore.ieee.org/servlet/
opac?punumber=2899](http://ieeexplore.ieee.org/servlet/opac?punumber=2899)

*International Organization for Standardization
(ISO) 1940-1:2003 Mechanical Vibration – Balance
Quality Requirements of Rigid Rotors in a
Constant (Rigid) State –Part 1: Specification and
Verification of Balance Tolerances*

Available at: [www.iso.org/iso/home/store/catalogue_ics/
catalogue_detail_ics.htm?csnumber=27092](http://www.iso.org/iso/home/store/catalogue_ics/catalogue_detail_ics.htm?csnumber=27092)

*IEEE Std 1068-1996 Recommended Practice
for the Repair and Rewinding of Motors for the
Petroleum and Chemical Industry*

Available at: [http://ieeexplore.ieee.org/servlet/
opac?punumber=4382](http://ieeexplore.ieee.org/servlet/opac?punumber=4382)

*ISO 10816-1 Mechanical vibration – Evaluation
of machine vibration by measurements on non-
rotating parts – Part 1: General guidelines. 1995*

Available at: [www.iso.org/iso/catalogue_detail.
htm?csnumber=18866](http://www.iso.org/iso/catalogue_detail.htm?csnumber=18866)

*Underwriters Laboratories (UL) 674 Electric
Motors and Generators for Use in Division 1
Hazardous (Classified) Locations, 2001 edition.*

Available at: [www.ul.com/global/eng/pages/
solutions/standards/accessstandards/catalogofstandards/
standard/?id=674_5](http://www.ul.com/global/eng/pages/solutions/standards/accessstandards/catalogofstandards/standard/?id=674_5)

*ISO 9001:2008 Quality Management Systems
- Requirements*

Available at: [www.iso.org/iso/home/store/catalogue_ics/
catalogue_detail_ics.htm?csnumber=46486](http://www.iso.org/iso/home/store/catalogue_ics/catalogue_detail_ics.htm?csnumber=46486)

*Electrical Apparatus Service Association (EASA)
Technical Manual*

Available at: www.easa.com/node/73108

Reference

Quality Electric Motor Repair: A Guidebook for Electric Utilities. This document, prepared by Washington State Energy Office, was originally co-sponsored and printed by Bonneville Power Administration as DOE/BP-2747, Nov. 1995 and Electric Power Research Institute as EPRI TR-105730s, June 1996. It is available for download at www.osti.gov/bridge/product.biblio.jsp?osti_id=237370.

Original text authored by Johnny Douglass,
Washington State University Energy Program.

Co-sponsored by:



Copper Development Association
260 Madison Avenue
New York, NY, USA 10016

U.S. DEPARTMENT OF
ENERGY

Energy Efficiency &
Renewable Energy

About the Office of Energy Efficiency and Renewable Energy

The Office of Energy Efficiency and Renewable Energy (EERE) invests in clean energy technologies that strengthen the economy, protect the environment, and reduce dependence on foreign oil.

Advanced Manufacturing Office

U.S. Department of Energy
Energy Efficiency and Renewable Energy
Washington, D.C. 20585-0121

Improving Steam System Performance: A Sourcebook for Industry, Second Edition

One in a series of industrial energy efficiency sourcebooks.

DOE/GO-102014-4356 • February 2014